

MAY 1974

# BME

BROADCAST MANAGEMENT/ENGINEERING

pm

Indiana University  
JUN 3 - 1974  
Library

## NAB SHOW -IN- PRINT ISSUE

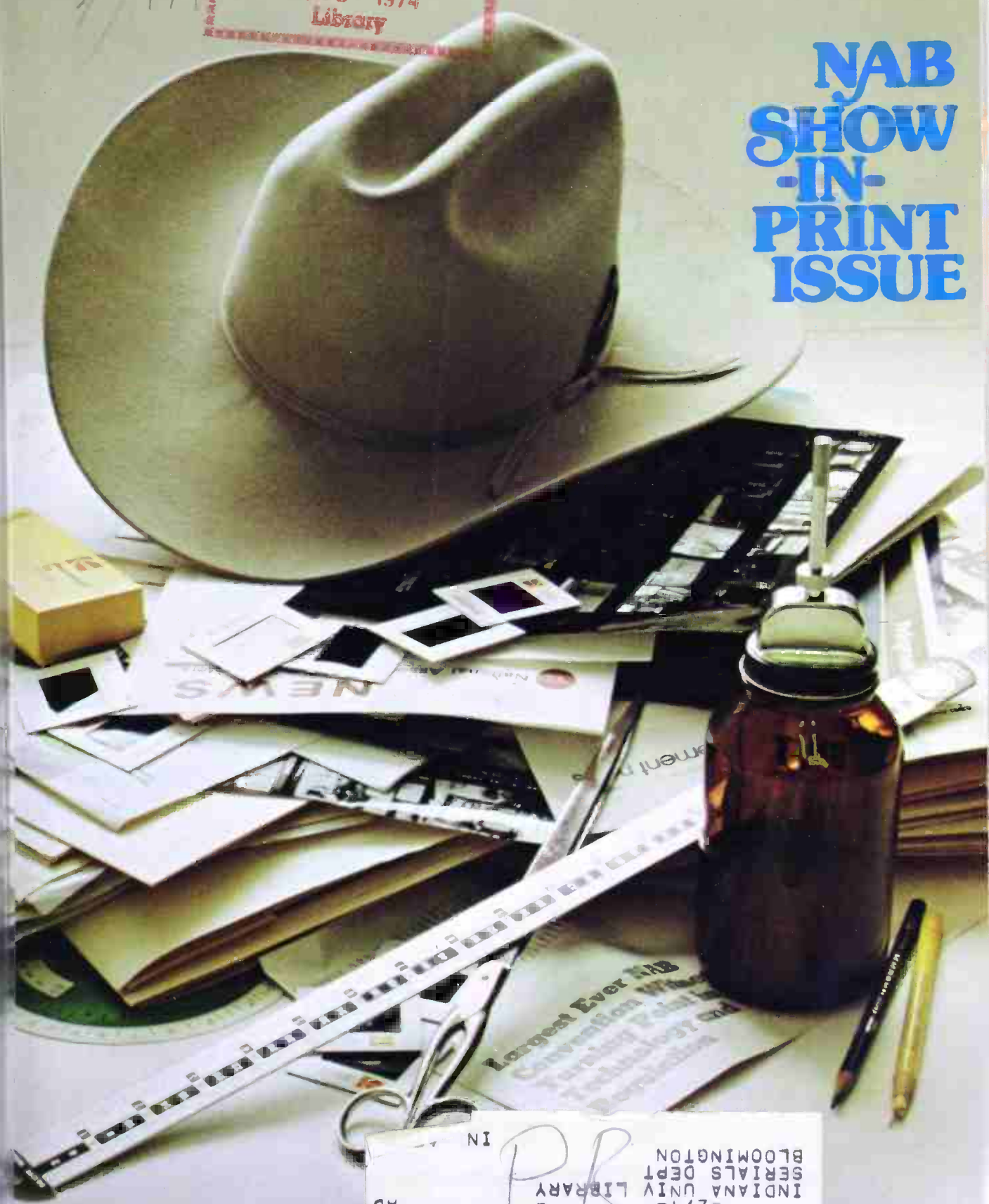

UNIN7223391-PA-  
- 274 -  
INDIANA UNIV LIBRARY  
SERIALS DEPT  
BLOOMINGTON  
IN  
AD -8751AV

At last count ...  
More than 150 broadcast  
managers had seen  
the light.

Seen the light, that is,  
from our new CEI 280  
lightweight/heavyweight  
broadcast color camera.



Directors and cameramen who have used the CEI 280 NTSC Broadcast Color camera have knowledgeably dubbed it "the Owl." The CEI 280 will pick up and broadcast at extremely low-end production light levels that at first seem absolutely ridiculous until you've watched it happen.

Plus, when you compare its relatively low cost and the smartly packaged operating and camera control units to any other broadcast color camera system, you have to concede it's more likely to be called . . . the "wise old owl."

Another plus, the CEI 280 weighs only 50 pounds which accounts for its other nickname, "the one man gang" studio camera.

To sum up, the CEI 280 features:

- Full remote control—all operating engineering controls located at the remote set-up panel.
- High performance at low level with state-of-the-art FET preamplifiers.
- Rugged, compact, modular construction.
- Two channels of intercom and external video feeds to camera head.
- Fast warm-up; long term stability.

However, there's lots more to this camera than meets the eye. Why not contact us and we'll provide full details and some interesting notes about how color broadcasters are putting "the owl" to work, day and night.

**CEI**

880 Maude Avenue  
Mountain View, Calif. 94040  
Telephone: (415) 969-1910

Circle 100 on Reader Service Card

# A MODULATOR for all seasons

## Four different modulators . . . four different needs.

You've probably never looked at modulators that way . . . but all too often RF systems use modulators whose performance either does not meet, or exceeds by far, the capabilities of the remainder of the system. That's no longer necessary.

DYNAIR now manufactures four different modulators . . . each designed to do the best job necessary for a specific requirement, and priced to fit it too. They save you money, since you pay for only the performance you need . . . no more, no less.

And, as the recognized leader in modulator design, we keep them up to date too. As new techniques are discovered and, particularly, as new integrated circuitry is developed, improvements in our equipment are promptly made. DYNAIR designed the first solid-state modulator and we continue to advance the state-of-the-art.

And — they're *all* modulators for *all* seasons — designed with compensated components to operate over broad temperature ranges. Many modulators won't.

DYNAIR . . . *the modulator people.*



The new MINI-MOD II\* is ideal when you want to operate several standard RF receivers from the audio and video outputs of a color VCR or VTR . . . use it in limited channel RF systems. The double-sideband output of the MINI-MOD II would also be seen in adjacent channels! (\$250)



For MATV and educational RF systems, the new TX-3A\* does the trick. Its internal filtering licks the adjacent channel color problem so the TX-3A can be added as easily as an off-air signal. (\$495)



But, for critical CATV applications, you should consider the DYNA-MOD II\*. It will assure top performance in this more demanding application . . . and it meets the FCC requirements for CATV modulators. (\$1250)



Now, if you are a CATV engineer who is really a purist, or if you have a broadcast, microwave or translator exciter requirement, take a look at the ultimate in currently available modulators — the new TX-40A Television Exciter\*. Its performance will seem unbelievable to any engineer who is familiar with the current state of the art. (\$2475)

**DYNAIR ELECTRONICS, INC.**  
6360 FEDERAL BLVD. SAN DIEGO, CALIF. 92114  
TELEPHONE: 714-582-9211

\* Available on CCIR Standards



# BM/E

BROADCAST MANAGEMENT/ENGINEERING

MAY 1974/VOLUME 10/NUMBER 5



With judicious scaling and some scissors work, it all fits—beginning on page 24.

**BROADBAND  
INFORMATION SERVICES, INC.**  
274 Madison Ave.  
New York, N.Y. 10016  
212-685-5320

Editor  
**James A. Lippke**  
Associate Editor  
**Robin Lanier**  
Contributing Editor  
**M.L. Hollowell**  
Assistant Editor  
**Djuna Zellmer**  
Editorial Assistant  
**Cheryl L. Settle**  
Art Director  
**Gus Sauter**  
Production Manager  
**Helen Horan**  
FCC Counsel  
**Pittman Lovett Ford  
and Hennessey**  
Publisher  
**Charles C. Lenz Jr.**

- 6 Broadcast Industry News**  
*Fairness Doctrine—more controversy*
- 16 Interpreting the FCC Rules and Regulations**  
*Public Opposition to Broadcaster Operations*

## 24 NAB Show-In-Print 1974

Digital circuitry	25
Wiley Talk	28
Helical vs. quad	25
Time base correctors	30
Super TBCs	32
Electronic journalism systems	32
Studio cameras	36
TV Lighting	37
New production switchers	37
Video distribution gear	40
Character gens	42
Videotape editors	46
Videotape	46
Radio automation	50
TV automation	54
Business automation	56
Transmitters	56
Monitors and test gear	62
Consoles	78
Tape recorders	80
Audio equipment	84

- 64 Great Idea Contest**  
*10 more ideas for reader evaluation*
- 69 Broadcast Equipment**  
*New and significant products for broadcasters*
- 87 New Literature**  
*Useful reading materials*

**CM/E: A supplement for those with cable interests;  
following page 68**



BM/E, BROADCAST MANAGEMENT/ENGINEERING, is published monthly by Broadband Information Services, Inc. All notices pertaining to undeliverable mail or subscriptions should be addressed to 274 Madison Ave., New York, N.Y. 10016. BM/E is circulated without charge to those responsible for station operation and for specifying and authorizing the purchase of equipment used in broadcast facilities. These facilities include AM, FM, and TV broadcast stations; CATV systems; ETV stations; networks and studios; audio and video recording studios; consultants, etc. Subscription prices to others: \$15.00 one year, \$25.00 two years. Copyright © 1974 by Broadband Information Services, Inc., New York City. Controlled circulation postage paid at Easton, Penna.



## LINEAR EFFECTS IN FIVE MODELS

The most advanced concepts in television production switching and special effects are now available in any of five different models from our 1600 Series catalog. Each switching system contains a thoroughly modern special effects system which utilizes linear control elements permitting video keys and split screen effects not possible with conventional equipment. For example, linear switching can produce chroma keys of translucent objects or a soft transition split screen.

The five standard models currently available range from a 16 input, 4 bus unit with a single mix/effects system to a 24 input, 7 bus unit with three complete mix/effects systems. Intermediate models are available with either 16 or 24 inputs and dual mix/effects systems. We are confident that one of the GVG standard models will suit not only your operational requirements, but your budget as well. Write us for complete description and specifications.

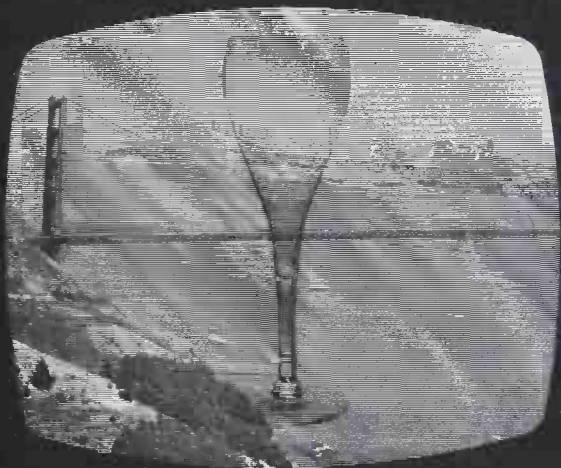

**THE GRASS VALLEY GROUP, INC.**



A TEKTRONIX COMPANY

Circle 102 on Reader Service Card

# BROADCAST INDUSTRY NEWS

## NAB Supports Radio All-Channel Legislation

The NAB has joined in the support of a law that would make mandatory for all radio receivers above a certain minimum price to have capability of receiving both FM and AM broadcasts. Major foundation of support for the legislation in the U.S. Congress comes from the Joint Committee for All-Channel Legislation, a broad-based group representing broadcasters, retailer's organizations and citizen's groups. Chairman of the Committee, Kenneth Cox, a former FCC Commissioner and now a Washington, D.C. lawyer, said that many state broadcasters' associations are passing resolutions favoring the proposed law, and that the number of U.S. Legislators supporting it, is growing.

The Senate All-Channel Radio Bill, S-585, was introduced by Sen. Frank Moss (D-Utah), and the House version, HR-8266, is co-sponsored by Rep. Lionel Van Deerlin (D-Calif.) and Rep. Clarence J. Brown (R-Ohio).

## Japanese Conducting Study of U.S. Broadcasting

Japanese broadcasters are interested in how U.S. broadcasting systems operate. Keichii Nagashima, program director for NHK—non-commercial television in Japan, is on a one year tour of U.S. Broadcasting facilities, doing extensive research in U.S. TV.

Because of their interest in possibly broadcasting actions of the DIET, the Japanese legislative body, Japanese TV officials have studied the televised coverage of state legislative actions in the state of Florida.

## FCC Concerned About TV Contest Practises

Concerned with the rising number of licensees who have conducted contests that have adverse effects, are unfairly conducted, are misleading, or falsely advertised, the FCC has outlined stronger action. The Commission sent to all broadcast licensees a notice detailing some of the questions raised in

conducting contests, and indicated that such conduct would in the future be considered in the license renewal procedures. Additionally, the Commissioners said that they would consider the feasibility of adopting rules in this area so that the full range of sanction would be available to them.

## Fairness Doctrine—More Controversy

... FCC: In the past few months, the FCC has received numerous complaints of violation of the Fairness Doctrine, and has denied most of these. The Commission has made it clear that complaints must be specific, substantiated and reasonable.

... ABC: Not taking any chances, ABC refused to air a particular Dick Cavett show on the regular schedule. On the show, Cavett interviewed four of the best known radicals of the '60's. ABC's rationale was that perhaps the show violated the Fairness Doctrine in not presenting enough of an opposing view. Eventually ABC did air the show as a special, but added a rebuttal by two representatives of the political right, at the end of the leftists' interview.

Cavett disagreed with ABC's decision in that he thought he, as the interviewer, presented a contrasting view. One of the rebutters, Jeffrey St. John a conservative columnist, seemed to agree with Cavett.

... NAB vs. Coalition of Congressmen: NAB president Vincent T. Wasilewski, opposed demands by coalition of Congressmen that broadcasters carry announcements critical of oil company advertising. Wasilewski said that broadcasters "have presented an enormous amount of material relating to the energy crisis," in many forms presenting differing views.

"Unlike Section 315, the Fairness Doctrine does not require 'equal time'. It simply attempts to insure that the public receives conflicting views of controversial issues of public importance which are broadcast. The licensee is the sole arbiter of the format and spokesman to present such conflicting views... the impression should not be left that because a station has presented advertisements for oil companies, it must necessarily broadcast the an

continued on page

## NAB Convention Highlight—A Modular Quad



(See NAB Show-in-Print report, beginning page 28, for a run down of all exhibits) Designed as a modular VTR, the new Ampex AVR-2 can be set up anywhere and takes up but one-third to one-half the space needed for existing quad systems. Prices range from \$69,000 to \$92,000, depending on options. Within two weeks of the convention Ampex had contracts in hand totalling over \$2 million. Latest customers include three production companies: WSM (Nashville), Compact Video (Los Angeles), and Telefax (Montgomeryville, Pa.).

It's not a lot of money  
for the camera...

it's a lot of camera  
for the money



Hitachi Shibaden's FP-1200 Plumbicon\*... the broadcast-quality color camera with the down-to-earth price tag.

Excellent color fidelity and sensitivity, plus three-tube efficiency are just two of the many outstanding features that will make the FP-1200 a valuable addition to your studio operation.

Especially for broadcast, cable, medical, training and educational applications.

Consider these features: Broadcast I & Q encoder; improved F.E.T. pre-amplifiers; new dichroic mirror assembly; 6 db gain. The FP-1200 is the only low-cost color camera with bias-light. It produces quality color at 10 foot candles.

Another important plus. Serviceability and stable performance mean minimum maintenance.

Add in the many other features you'd expect from a camera like this: 10-1 zoom lens with automatic iris control, built-in encoder, color bar generator, color temperature compensator, horizontal aperture correction, extended red, solid state design... to name just a few.

For a live demo, specs and pricing, call or write Hitachi Shibaden... "The Image Makers."

We think you'll agree that the FP-1200 is a lot of camera for the money.



**HITACHI SHIBADEN**

Corporation of America

Exec. Off: 58-25 Brooklyn-Queens Exp'y,

Woodside, N.Y. 11377 Phone 212-898-1261

Offices in Chicago, Los Angeles, Dallas, Toronto

Circle 103 on Reader Service Card

"MAX?  
THIS LOOKS LIKE  
A BRAND NEW  
RCA HEAD"



"WRONG MAXINE.  
IT'S BETTER  
THAN NEW.  
BUT RIGHT, IT IS AN RCA!"

Maxine and Max are announcing the second "world's greatest mouse trap"—Videomax "M" Series refurbished RCA High Band and Low Band quad heads. The first was, of course, the highly successful Mark X and Mark III, "L" & "M" Series.

The reason for this success is that we specialize in furnishing you with the finest and widest choice of refurbished quad heads. That's why only Videomax can offer a **200 hour warranty for RCA heads for only \$890.**

So, **the choice is yours.** But is there really a choice?

When you return a video head to us, whether it's Ampex or RCA, it is completely refurbished from stem to stern. Every unit is then certified to meet or exceed the industry's highest performance standards, insuring total compatibility.

Our refurbished RCA heads carry the same **"no risk" guarantee** as featured with all Videomax heads, heads which for years have been delivered to the major networks, broadcast stations and production houses. We'll continue the same fast service—ten working days or less—and we have the only field force dedicated to this business.

For more information from the Innovators, write or call collect.



**VMX**™ videomax

**Videomax Corporation**  
Subsidiary of Orrox Corporation  
154 San Lazaro Avenue, Sunnyvale, California 94086  
Telephone: (408) 739-5391

Circle 104 on Reader Service Card

## NEWS

nouncements advocated by this particular group."

White House: In late February Deputy Special Presidential Asst. Dr. John McLaughlin spoke on KNX/FM Los Angeles, on behalf of President Nixon. He replied to charges made earlier on that station by Frank Mankiewicz, former campaign director for Senator George McGovern, against the President. Mankiewicz had charged that President Nixon "filed a false income tax return," and that "There's the obstruction of justice in the case of the CIA. There are willful assaults on the Constitution. There's enough there" for impeachment. The station then offered the President an opportunity to respond. McLaughlin supported President Nixon's justification in claiming the tax deduction, and attacked the press' behavior in press conferences with the president.

### TV's Primacy as Information Source

Television is the public's prime source of information about the energy problem, pollution and consumer protection, according to a January 1973 poll conducted by R.H. Bruskin Associates, New Brunswick, NJ, for the Television Information Office.

### NATPE—Strong Objection To Programming Pressure

At the National Association of Television Program Executives convention, members had a special ballot on programming by pressure from citizens or special interest groups. The majority of those surveyed would prefer "suggested" FCC guidelines for dealing with special interest groups. That would be better than specific policies or no action at all, according to poll results. Basic feelings were that outside groups should not be allowed to determine what programs should be carried when they should be shown, or who should have access to appear on them.

### Supreme Court Upsets FCC Cable Fee Rules

In early March, the Supreme Court ruled that the present charges by the FCC on cable operators amounts to tax, which is not in the Commission jurisdiction to impose. The FCC was told that it could impose fees for regulation, but not on the blanket basis under which it was operating.

The ruling also had favorable implications for broadcasters, who through

continued on page



**OB'QS** [äb-'kwiz]<sub>n</sub>: (one bus quad split) A device manufactured *only* by American Data Corporation: a device which generates a quad split effect using *no* switch buses on your primary switcher: a device which now provides a quad display as a *primary* switcher input: a device which may be used with *any* switching system with as few as two buses or as many as (?): a device which sells for \$1250, or \$1600 with colorized borders: a device *you* should have.

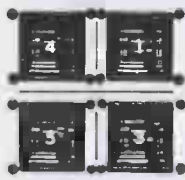

QUAD SELECT



QUAD ASSIGNMENT



## Model 1290 "O B Q S"



# AMERICAN DATA CORPORATION

AN **AIRPAX** COMPANY

315 WYNN DRIVE, N.W. P. O. BOX 5228 HUNTSVILLE, ALABAMA 35805 TEL. 205-837-5180

ADC SOUTHEAST  
DAVE SPINDLE  
205-837-5180

ADC SOUTHWEST  
RUSSELL TREVILLIAN  
713-941-7272

ADC MID-ATLANTIC  
DWIGHT WILCOX  
301-460-1454

ADC NORTHEAST  
JOHN SULLIVAN  
617-237-2600

Circle 105 on Reader Service Card

# Specs you expect at a price you don't.

## Secondary controls and functions include:

Display Size (105% and 80% scan).  
Internal/External sync. selector.  
External sync. input (2) — looping.  
Termination 75 ohms.

## Input circuit

High impedance looping (1 meg OHM in parallel with less than 8 pf) via two rear-mounted SO-239 VHF connectors. (75 ohms when terminated by a built-in switch).

## Input Sensitivity

.25 to 4.0 volts p-p sync. negative to give a minimum of 50 volts p-p signal at the kinescope.

## Frequency and phase response

10 MHz bandwidth  $\pm$  3 db at 50 volt p-p output.

## Linearity

Vertical: Better than 2%  
Horizontal: Better than 3%  
(Capability better than 1% vertical and horizontal).

## D.C. Restored

## Display Size

Switchable from 105% to 80% of full picture size.  
Geometry  $\pm$  2%.

## Resolution

Greater than 800 lines in central 80% of display area at less than 30 microamps beam current.

## Standards

NTSC. CCIR

## Models Available

9" single rack, twin rack or case.  
11" single rack or case  
14" single rack or case  
23" case model with stand,  
ceiling or wall mount optional  
stand, ceiling or wall mount,  
speaker/amplifier pod, pulse  
cross kit and anti-glare treatment.



EVM9. 38 sq. in. screen.

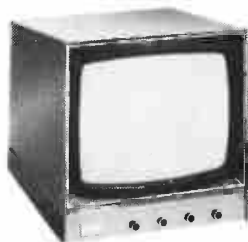

EVM-11. 61 sq. in. screen. Also available in single rack mount.



EVM-23. 283 sq. in. Optional anti-glare picture tube.



EVM-14R. 82 sq. in. Also available in case model.

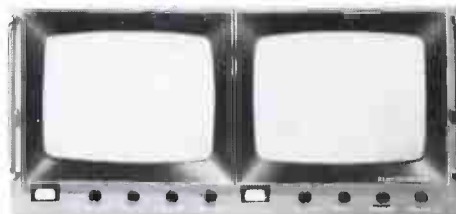

EVM9R2. Rack-mounted twin 38 sq. in. screens. Also available in single rack mount.

# ELECTROHOME

... an extra degree of excellence in video equipment for every application.

809 Wellington Street North, Kitchener, Ontario.  
9314 West 122nd St., Palos Park III. 60464  
(Telephone (312) 361-4636)



Circle 106 on Reader Service Card

## NEWS

the NAB petitioned the FCC to rewrite its fee schedule to reflect the Court's ruling that the FCC cannot require regulated bodies to underwrite its annual operating costs. NAB also urged the Commission to suspend for one year its annual license fee because of the conflict with the Supreme Court opinion.

## More TV Specials— But Lower Ratings

The TV networks aired 50 percent more specials in the fourth quarter of 1973 than in the same period of 1972, according to a study by the J. Walter Thompson Co. The study found a five percent decrease in ratings from the preceding year, but an 11 percent higher rating for average regular prime-time programming. The JWT study also concluded that heavy promotion is needed for specials; specials dealing with a holiday theme get higher ratings; and popular feature films generally outrate specials.

## Newsletter For Women Members of NAEB

The NAEB's new office of women's activities has begun a monthly newsletter to be circulated to women members of NAEB. The newsletter will serve as a formal means for women members to communicate with each other. Discussion is under way for a special subscription rate for non-members, if the response warrants it.

## Sales Leap For Blank Magnetic Tapes

Recent research indicates that nearly 175 million blank cassette tapes and 25 million blank 8-track cartridges will be purchased this year, mainly by youth. According to the research conducted by Longines Symphonette Co., sales projections for 1976 reach 340 million blank cassettes. The tapes are being used for recording speech homework, school lectures and public speeches, as well as for music.

## New Electro-Optic Modulator Compatible with ICs

A new electro-optic modulator developed by RCA Labs can modulate a laser beam to carry up to 20 TV programs at one time. The modulator is compatible with integrated circuits and can operate over wave lengths extending from the visible to the near infrared.

As many as 25,000 persons will be  
continued on page 11

# One of the very best broadcast color monitors is on the shelf...waiting to brighten your day.

It's known as the TCB-19, from the Miratel Division, Ball Brothers Research Corp. We call it one of the very best because TCB-19 users report a consistently high level of performance.

Dual regulated power supplies hold picture stability with wide input voltage variations. Solid-state circuitry insures low maintenance and consistent performance over the long haul. Switchable long or short time-constant AFC adds to monitor usefulness for VTR alignment, and a front panel switch allows for selection of two video inputs. All critical set-up and adjustment controls are front-mounted for convenience.

The TCB-19 performs the way it's built, and it's built well. Check it out!



## The rest of the family is also standing by.



And it's a large one. Color and monochrome monitors from 9 to 25 inches. Rack-mounted, frame-mounted, broadcast or information display. All Miratel monitors feature over-design of critical circuitry for exceptional long-term performance. Each unit is power aged, and subjected to quality control checkout before shipping. Miratel monitors are designed to

serve as your single best check of signal quality.

We also offer a variety of video accessories from special effects generators to waveform monitors to video signal multiplexers. Depend on the Miratel family for your television equipment needs. Call or write for information.

### MIRATEL DIVISION

BALL BROTHERS RESEARCH CORPORATION • 1633 TERRACE DRIVE • ST. PAUL, MINNESOTA 55113 • (612) 633-1742

Circle 107 on Reader Service Card

# The Best Choice For AM Monitoring

modulation only or...



FCC Type Approval 3-209

...frequency and modulation



FCC Type Approval 3-195

## both make all proof-of-performance measurements

Now you can satisfy all of the FCC monitoring regulations and your budget, and still get the quality and accuracy that make TFT the leader in broadcast monitors.

For modulation only, choose the Model 732. Or, for both modulation and frequency, make your choice the Model 713.

Both give you all the advanced TFT features, such as remote monitoring without an RF amplifier.

Additionally, with the Model 713, both actual frequency and frequency deviation can be digitally displayed and calibrated against NBS.

Of special importance, you get digitally settable plus and minus peak flashers. They eliminate the ambiguities of conventional, potentiometer-type controls, and allow you to set the peak limit up to 129 percent, in one percent steps. As a result, you can operate at the maximum allowable modulation, without fear of exceeding FCC limits.

So, for precise, accurate and reliable monitoring make your choice TFT. Call us collect for immediate delivery.

**TFT** TIME AND FREQUENCY TECHNOLOGY, INC.  
3000 OLCOTT STREET, SANTA CLARA, CA 95051 (408) 246-6365

Circle 108 on Reader Service Card

## NEWS

able to talk simultaneously over a single laser beam, when the device is employed in a high grade telephone circuit. Other applications will be for space and military systems using fiber optic transmission lines, and for a variety of systems such as facsimile that require a wide range of laser modulation.

Dr. Jacob M. Hammer and Dr. William Phillips of the RCA Laboratories developed the new light modulator with support in part from the Office of Naval Research.

## Business Briefs

Due to spiraling costs of various components, Sola Electric Division of Sola Basic Industries has set an across-the-board price increase of five to six percent on all standard line voltage regulators, constant voltage transformers and power supplies. . . . **Radio Television Belge** (Belgium) has ordered two television outside broadcast vehicles from **Marconi Communications Systems Ltd.**, a FEC-Marconi Electronics Co. Similar complete outside broadcast vehicles have recently been delivered to the Australian Broadcasting Commission, the New Zealand Broadcasting Corp. and the Yugoslav Joint Radio and Television Committee.

**International Video Corp.** is erecting a new 130,000-sq.-ft. manufacturing facility at its Sunnyvale, California complex. . . . Big-screen color TV production hit a new high last year with output (imported and manufactured last year) rising 10.5 percent to 3.6 million sets.

**GRT Music Tapes** reported a highly successful "Pro-Forum" promotional trip to Puerto Rico, which gathered representatives of most of the key distribution and rack-jobbing concerns in the country. Each of these representatives reached or surpassed a sales quota to qualify for the trip. The Pro-Forum had as its theme the world of professional sports, and featured a group of nationally-acclaimed sports figures hosting.

**Century Communications Corp.** purchased from **Western States Producing Company** the cable television system serving Brunswick, St. Simons Island, Sea Island and Glynn County, Georgia. . . . The Radiation division of **Harris—Intertype Corp.** won a \$6.1 million contract from the AP, to manufacture receivers and transmitters from the AP's new Laserphoto news picture system.

**Warner Communications Inc.** reached an agreement in principle for sale of substantially all its interest in . . . continued on page 14

Circle 109 on Reader Service Card



# Think smaller!

You don't have to carry an albatross around your neck... or 75 lbs. on your back and shoulder to shoot great video tape in the field. And you don't have to wait for hours—or even days—to see the film you've

AKAI's VTS-150—a totally portable color VTR system—takes the burden back. Weighs just 22 lbs. Completely compatible with any other video if you're now using. And provides direct on-the-air broadcasting capabilities when used with any of the time-base correctors available today. It's battery or AC operated. So it goes wherever you go. Which means you never need film again. Or film processors, soundmen, film editors, lighting men, deliverymen, directors, lab men, etc.

The AKAI VTS-150 is a complete color VTR system. Including a color camera with 6-to-1 zoom lens, servo-controlled iris and microphone... viewfinder/playback monitor... and a color monitor that utilizes inexpensive 1/4" video tape. Plus automatic control, stop-motion and sound dubbing capabilities. Don't let its small size fool you. The VTS-150 is a superbly designed professional color VTR system with many of the features of video systems costing many times more. And the smallest part of the system is the price. Only \$6495.

subject to change without notice.

Mail the coupon today for complete information.  
**AKAI America, Ltd./ BM/E-4**  
 2139 E. Del Amo Blvd., Compton, Calif. 90220

Please send me literature on AKAI's new Color VTR System.  
 Please send me literature on AKAI's Black & White Systems.  
 Please arrange a demonstration of the above.

Name \_\_\_\_\_ Title \_\_\_\_\_  
 Firm \_\_\_\_\_ Phone \_\_\_\_\_  
 Address \_\_\_\_\_  
 City \_\_\_\_\_ State \_\_\_\_\_ Zip \_\_\_\_\_

**AKAI**  
 Innovators  
 America, Ltd./  
 2139 E. Del Amo Blvd.,  
 Compton, Calif. 90220  
 337-3880

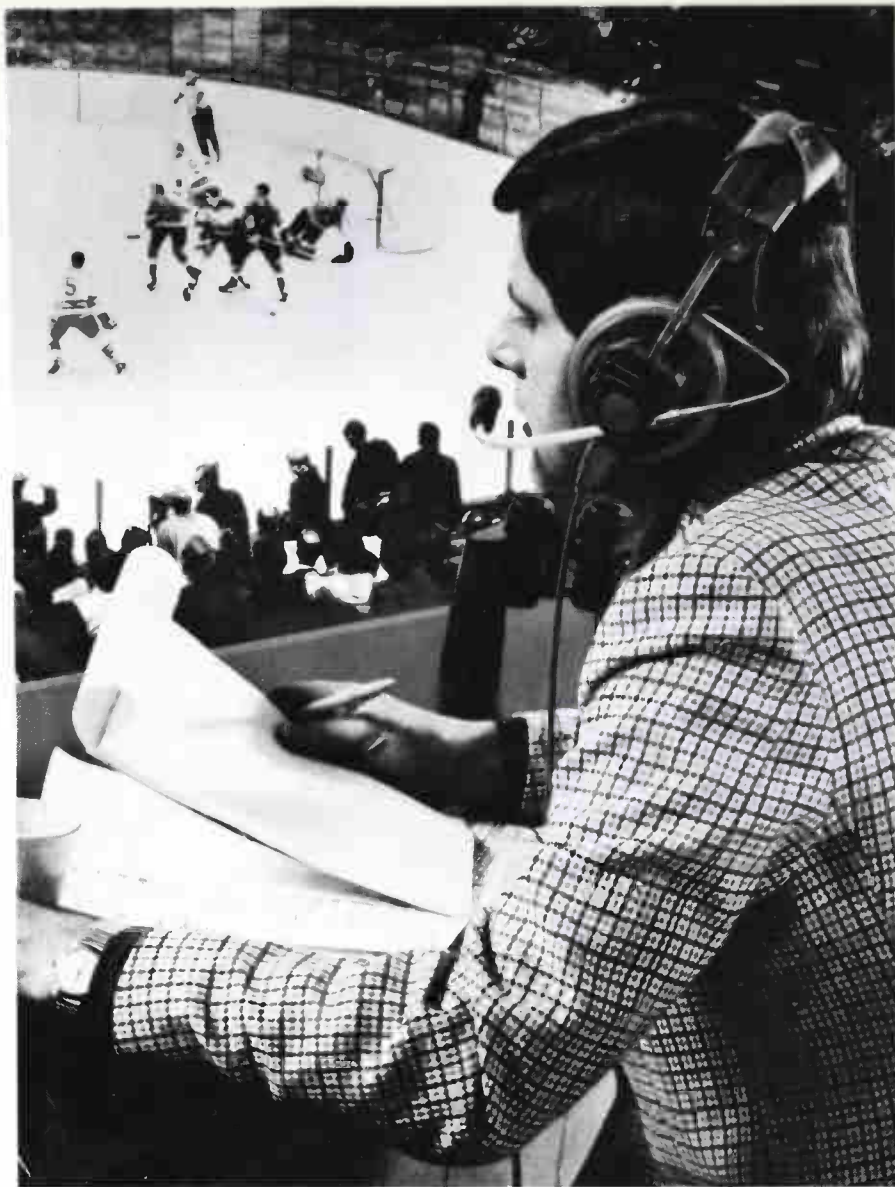

## All the color, all the action, with hands free mobility... the Telex Sportscaster Headset.

Combine the absolutely finest wide range, omnidirectional, dynamic boom microphone with an equally high-performance binaural headphone, and you have the superior headset for sportscasters... the Telex CS-90.

It is designed for mobile or fixed station live broadcasting cue and program monitoring, all with free hands and head movement convenience.

The audience at home hears every word clearly and crisply, yet still has background crowd noise for atmosphere. Circumaural earcushions screen out sounds in the immediate area, so that special acoustic facilities are unnecessary.

The Telex Sportscaster Headset

is built of high-impact ABS plastic and stainless steel to stand up to constant moving, hard bumps and all kinds of weather. And it's supplied with a convenient inline "push-to-cough" switch which mutes the microphone when pressed. For complete information write Telex Communications, Inc., 9600 Aldrich Avenue, South, Minneapolis, Minnesota 55420.

PRODUCTS OF SOUND RESEARCH  
**TELEX**  
COMMUNICATIONS, INC.

CANADA: Telax Electronics Ltd.,  
Scarborough, Ontario

INTERNATIONAL: Telex Export Dept., 9600 Aldrich Ave. S.,  
Minneapolis, Minn. 55420 U.S.A.

Circle 110 on Reader Service Card

## NEWS

National Kinney Corp. to a combination of Societe de Gestion Immobiliere et Mobiliere, S.A. (SOGIM), a European holding company, and certain institutional investors.

Anixter-Pruzan has developed a combined safety inspection check list and equipment order form for CATV operators. The new form can be used to make daily safety inspections in accordance with the requirements of OSHA, and then be forwarded to the company for filling order needs. Communico Oceanic Corporation of Honolulu, Hawaii, a wholly owned subsidiary of Communico, Inc. of Hartford, Connecticut, has purchased KPOI, AM and FM radio stations of Honolulu, paying close to \$600,000 to the Valjon Trust of Minneapolis for the two properties. Communico plans to change the call letters for the FM station to KHSS.

Cinema Products Corp. has moved to new and larger quarters at 2037 Granville Ave., Los Angeles, Telephone number remains the same.

Motion Picture Laboratories, Inc. is now franchised to provide NO-EN and VACUUMATE film services.

Anixter-Pruzan has moved its Southwest district office and warehouse from Los Angeles to Santa Ana. The company will share the larger facilities with Anixter-Los Angeles, part of the Anixter Wire and Cable division. New address is 2228 South Ritchey St., Santa Ana. The UPI Cable Newswire began service to the Telesis Corp. system at Franklin, Indiana, and several other Telesis systems in Indiana. GRT Music Tapes acquired an exclusive five year tape license for the new Passport Records label, and extended its exclusive license for Sire Records for an additional five year period.

Jarmain Teleservices Ltd., London, Ontario, will complete this year one of eastern Canada's last major CATV systems, spanning 200 strand-miles and representing \$1.7 million. Link, designed by Network Analysis Corp., Glen Cove, NY, through application of computers, will be owned and operated by Kingston Cable TV Ltd.

Home Box Office, Inc. has formed a new subsidiary, HBO Studio Productions, Inc., to manage company's cable pay TV operation center at 120A E. 23rd St., Manhattan and to offer studio services and facilities on a rental basis.

The Winegard Company has introduced a new switch, "Cablemate," that allows cable TV subscribers to switch instantly from antenna signal to cable signal without any interference.

continued on page 7

# MOVIOLA

## When it comes to flatbeds, nobody else cuts it.

Because nobody else in the world knows your film cutting needs like Moviola. That's why our new six-plate, four-plate and two-plate flatbed editors can save you time and money in a way nobody else can match.

They're simple, fast, flexible and precise. With solid, practical features you won't find all together anywhere else. Like picture/sound interlock at ten times sound speed. Electronically controlled picture/sound inching and single-frame viewing. Immediate stop on a precise frame at sound speed with no spillage or tension loss. Frame/footage or second/minute display. Clear and sharp 8½" x 11½" viewer that provides full viewer brightness with no film damage. Integrated circuit audio system. And more.

Remember, we've been a basic, everyday part of the American motion picture industry for more than fifty years. And that kind of on-the-job experience is the reason why our new flatbeds will outperform anything put up against them. Why take a chance on anything else, when you can get a Moviola?



magnasync

moviola

magnasync/moviola corporation

A Subsidiary of Craig Corporation

5539 RIVERTON AVENUE/NORTH HOLLYWOOD, CALIFORNIA 91601/(213) 877-2791

Circle 111 on Reader Service Card

# Public Opposition To Broadcaster Operations

By Frederick W. Ford and Lee G. Lovett  
Pittman, Lovett, Ford and Hennessey, Washington, D.C.

Over the past few years, the Commission has come under increasing pressure from citizen groups and individuals alike to provide operative tools for the voicing of grievances against station operations. Challenges to existing licenses have become commonplace; in renewal proceedings, the issues run the gamut from discrimination in employment, to inadequate community needs ascertainment, to inadequate legal, financial, character or other qualifications.

To date, the Commission has defined broadcaster obligations regarding, among other things, *personal attacks* and *political broadcasts*. Regardless of one's disposition toward these Commission rules and procedures, the broadcaster *must* be aware of *how*, *when*, and *why* citizen groups or individuals can take broadcasters to task at the Commission.

## Broadcast Procedure Manual

In an effort to facilitate citizen access to the FCC, the Commission has issued a booklet entitled, "The Public and Broadcasting—A Procedure Manual."<sup>1</sup> As stated by the Commission, the manual's purpose is:

"... to outline procedures available to the concerned citizen and to provide information and practical advice concerning their use."

The Commission explains the scope of the Manual as follows:

"... an effort is made to outline the respective roles of the broadcast station, the Commission, and the concerned citizen in the establishment and preservation of quality broadcast services, to outline procedures available to the citizen, and to provide practical advice concerning their use. We are hopeful that the manual will encourage participation by members of the community..."

The Commission added a caveat by noting that complaints should *first* be communicated to the broadcast station. To avoid unduly impeding the Commission's processes "by the sheer bulk of the matters brought before it," the Commission suggests that "every effort should be made, both by the complainant and the licensee, to resolve any difference through discussion at the local level."

## Letter Complaints

Any individual or citizen group may file an informal complaint—at any time and in any form—with the Commission. Of course, the complaining party is urged to file its objection as soon after the alleged grievance as is practicable.

Since thousands of complaints are filed every year, the

Commission is faced with the formidable task of separating those "meritorious" complaints from those without merit. This task falls to approximately a half dozen Commission employees specifically assigned this function. If a complaint (1) does not allege a "substantial" violation of a federal statute or a Commission rule, regulation, policy, or (2) if inadequate information is submitted, a letter so explaining is sent to the complainant. If a complaint appears to warrant further inquiry, investigation of formal proceedings, additional Commission personnel are assigned. Investigation may take the form of (1) correspondence with the broadcast station or, less frequently (2) field inquiry. If the investigatory staff concludes that the broadcast station has committed a violation, it may recommend (1) *direct remedial action* (i.e., equal time for political candidates), or (2) in lieu thereof, *notation* of the violation in the broadcast station's file.

The Commission may implement a broad range of direct sanctions, including:

- (1) "... imposition of monetary forfeitures not exceeding \$10,000 . . . ."
- (2) "short-term renewal of license . . . [and]"
- (3) "denial of an application for renewal of license . . . ."

## Specific Procedures and Information Requirement

Yet, before such sanctions can be imposed, the Commission requires that the complaining citizen group provide individual tender specific information and follow specific procedures. These matters include complaints concerning: (1) equal time for political candidates, (2) the fairer doctrine, (3) the personal attack rule and (4) the rule governing political editorials. While complaining citizens should take up each of these four matters with the broadcast station, broadcasters should note that, *in some circumstances*, complaints may be made *directly* to the Commission. Thus, wary broadcasters should take extra precautions guard against violations involving any of the aforementioned matters.

## Political Broadcasts

A broadcaster who permits use of his station by a person who is a legally qualified candidate for public office *must* afford all other such candidates the use of the same station facilities. Candidates must make an "equal opportunity" request within one week of the broadcast giving rise to such a right. Broadcasters should note that

<sup>1</sup>37 Fed. Reg. 20510 (1972)  
continued on page 18



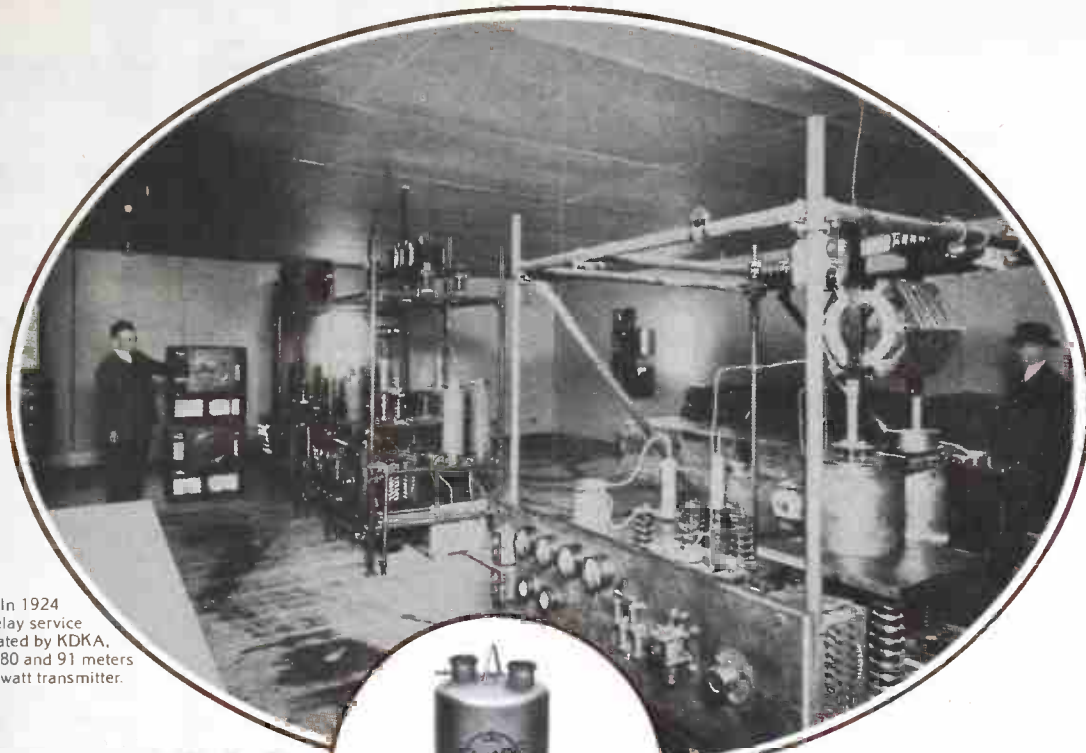

In 1924  
 relay service  
 operated by KDKA,  
 on 80 and 91 meters  
 by a 30 watt transmitter.



Today,  
 the EIMAC  
 X-2159  
 super power  
 tetrode.

# EIMAC brought broadcasting where it was to where it is.

50 years of progress in communications. 1924 saw the inception of widespread scheduled broadcasting in the United States and Europe. The first shortwave relay broadcast station was a success. The arc and spark transmitters of the early "twenties" were being eclipsed by the fragile, gassy vacuum tube.

Today, fifty years later, international and domestic broadcasting benefit from EIMAC's pioneer developmental work in vacuum tube technology. EIMAC leadership in high power and microwave devices of all types make possible applications considered impossible a few years ago.

EIMAC's family of high gain tetrodes, including the super power X-2159, are predominant for broadcast service, powering today's transmitters and ready to power tomorrow's super power transmitters.

EIMAC develops, others copy or fade away, as the last 50 years have proven.

Look to EIMAC for dependability and cost-effectiveness in vacuum tubes. EIMAC has the answer today for tomorrow's communication requirements.

For further information, contact EIMAC, Division of Varian, 301 Industrial Way, San Carlos, California 94070. Or any of the more than 30 Varian/EIMAC Electron Tube and Device Group Sales Offices throughout the world.



Circle 113 on Reader Service Card

# Neve introduces an end to air pollution.

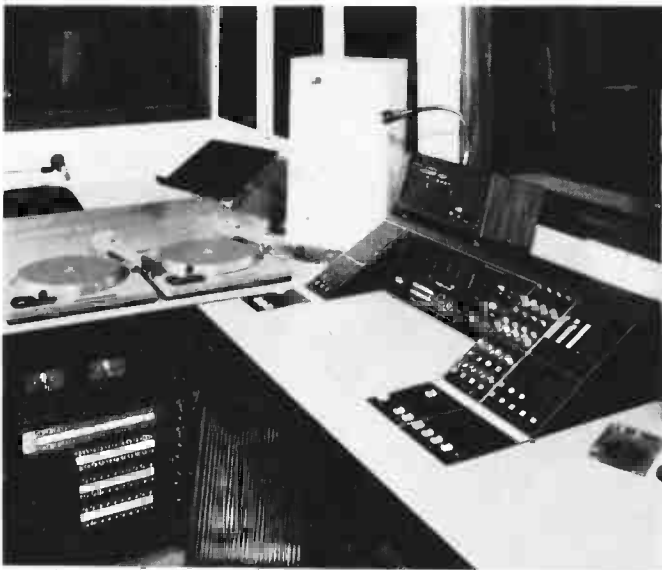

It's the new Neve 858 Audio Control Console. And it can help you avoid the "polluted", somewhat muddy and distorted sound that all too often rides the air waves.

With ordinary broadcasting consoles, you get ordinary results. But the Neve 858 is something else. It's designed to help your station produce the purest, richest sound in town, no matter how many rival stations there are in your area.

In this one console Neve combines 26 inputs, 6 stereo outputs, 6 mono outputs, simultaneous stereo/mono output capability, clean-feed input for automated systems, total harmonic distortion guaranteed to be less than 0.075%, and much more.

The sound of Neve is worldwide. Neve Consoles are used in broadcasting, music recording and film production in more than 48 countries. Why not get full details—before a competitive station does?

Rupert Neve Incorporated, Berkshire Industrial Park, Bethel, Conn. 06801 (203) 744-6230 • Hollywood: Suite 616, 1800 No. Highland Ave., Hollywood, Ca. 90028 (213) 465-4822 • Rupert Neve of Canada, Ltd., 2717-19 Rena Rd., Malton, Toronto, Ontario, Canada (416) 677-6611 • Rupert Neve & Co., Ltd., Cambridge House, Melbourn, Royston, Herts, England

# Neve

Circle 116 on Reader Service Card

## FCC RULES & REGS

continued from page 11

following types of programs which are *exempt* from the "equal opportunities" requirement:

- (1) "Bona fide newscasts;
- (2) "Bona fide news interviews;
- (3) "Bona fide documentaries (if the candidate's appearance is only incidental to presentation of the subject matter covered); [and]
- (4) "On-the-spot coverage of bona fide news events (including but not limited to political conventions and activities incidental thereto)."

While the "equal opportunities" doctrine does not apply to the four above-mentioned program types, broadcasters should be cognizant that they:

... must nevertheless meet the obligation imposed upon them under the Communications Act (to operate in the public interest) and the fairness doctrine (to afford reasonable opportunity for the discussion of conflicting views on controversial issues of public importance)."

Furthermore, the Commission has published a political broadcasting primer entitled "Use of Broadcast Facilities by Candidates for Public Office"<sup>2</sup> which contains interpretations of the "equal opportunities" requirement to facilitate candidates' rights under the requirement.

### Fairness Doctrine

A station (or network) which presents programming containing a specific point of view on a "controversial issue of public importance" *must* afford "a reasonable opportunity for the presentation of contrasting views as to that issue." Broadcasters should note that the fairness doctrine obligation applies to *all* programming, not just editorials; however, a *fair opportunity* (not *equal time*) must be afforded for presentation of contrasting views. The broadcaster has the further option of developing his *own* program presenting the contrasting viewpoint instead of permitting independent spokesmen to do so.

While the broadcaster has considerable latitude as to the viewpoints presented, experience indicates that a considerable number of fairness doctrine complaints are being made to the Commission. (i.e., NBC, in refusing fair reply time to a complainant after airing its program on "pensions" claimed that its presentation was *not* "one side of a controversial issue of public importance"; NBC appears ready to appeal an adverse Broadcast Bureau ruling<sup>3</sup> all the way to the Supreme Court.) Thus, broadcasters must realize that presentation of one side of controversial public issue, laudable as it may be, entails certain fairness doctrine "burdens" which may lead to confrontation at the Commission level by citizen complainants.

### Personal Attacks

When an attack is made upon the "honesty, character, integrity or like personal qualities" of a person or group during the presentation of views on a controversial issue of public importance, the broadcaster must (1) within one week after the attack, (2) notify the person attacked of the date, time and identity of the broadcast, (3) send the person attacked a script, tape or "accurate" summary of the attack, and (4) offer the person attacked a "reasonable opportunity to respond over the station's facilities free of charge." The personal attack rule *does not* apply to the four program exceptions enumerated in the "Political Broadcasts" section above; however, it *does apply* to

continued on page 2

<sup>2</sup>33 Fed. Reg. 13048 (1970).

<sup>3</sup>Accuracy In Media, Inc., 27 RR 2d 1523 (1973).

# RCA

# PrimeTime

There's an RCA Video Tape Recorder:  
For what you have to do. For when you  
have to do it. For what you have to spend.



## Your choice of a full line of quad VTRs for what you have to do now...

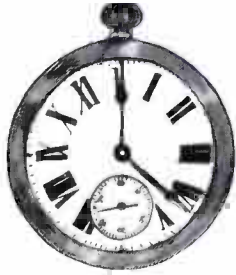

Planning your broadcast equipment needs entails maintaining an often delicate balance between the urgencies of production, the realities of finance, and pressures of time.

The RCA video tape recorders on these two pages were designed with these factors in mind. They perform the full gamut of video tape functions for whatever job you need to do. They represent the ultimate in cost effectiveness. And they are all available right now.

We present them here for your assistance in planning... and as an aid in making equipment decisions based on your needs in terms of time, money and production.

We've made the automatic station break machine even more automatic... it's an even greater value



A hundred eighty-four RCA Cart Machines are busily demonstrating their effectiveness in daily use around the world.

**The unsurpassed TR-70C is a bigger value than ever before... just check the price:**



Let's start this survey of RCA Video Tape Recorders right at the top of the line with the incomparable TR-70C. It's everything you want in a reel-to-reel VTR.

**"You won't find better performance specs anywhere than the TR-70C's."**

The big news is the list price of \$103,500, which includes those two features on broad-

casters' "Most Wanted" list: CAVEC for automatic correction of color errors. And a Color Dropout Compensator (DOC) for increased immunity from dropouts due to tape defects.

Unsurpassed in its video and audio specifications, the TR-70C is for the broadcast station or



other television facility that's into teleproduction and demands the very best in quality reproduction.

TR-70C quality pays off in day-in, day-out performance with minimum maintenance and in the extra dividend you can count on with quadruplex-quality equipment.



And we're pleased to announce that our new model, the TCR-100A, will be even more help to broadcasters. Already, we have a tradition to live up to.

This new Cart Machine includes a function called "Random Home", which enhances the machine's teleproduction capabilities by making it easier to go from playback to dub and back to playback again. If your station does a lot of commercial dubbing, you'll find "Random Home" a time and money saver.

Also standard on the new Cart Machine is a built-in computer interface, which allows a computer to sequence entire station breaks with real-time commands.

A third new asset: built-in prewiring for such important accessories as electronic insert and assemble editing and the Electronic Program Identifica-

tion System (EPIS), which displays an alphanumeric identification of cued and on-air cartridges.

Visitors at this year's NAB Convention saw another aspect of the TCR-100A automation potential. It was combined with a TCP-1624 Cartridge Film Projector and the new TAC-1 Programmer for the world's first all-cartridge film and tape station break.

**"Already we have a TCR-100 tradition to live up to."**

TAC-1 permits 15 program sequences (each of which may include as many as seven events) to be programmed automatically. Events can originate from any tape, film or slide source to provide station break automation that is not limited to a single type of machine.

**The new TR-61.  
No other machine  
in its price range has  
so much going for it.**



Exhibited for the first time in the U.S. at the recent NAB Convention, the TR-61 has no equal in its price range for studio workhorse applications. And at \$75,900 list, including CAVEC and DOC, there's no better buy.

The new TR-61 unit has a digital servo system controlling the headwheel and capstan motors that is identical to that in the deluxe TR-70C. Result: reliable servo operation with one-second lockup time.

Besides retaining the compact size of earlier economy VTRs, the money-saving TR-61 in-

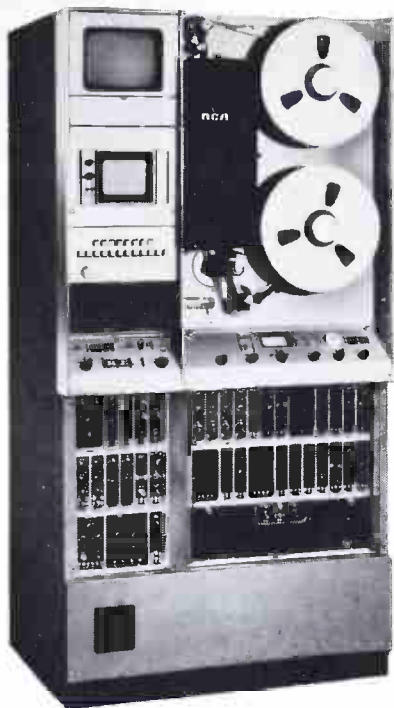

cludes many features found on more expensive machines, such as rear-side erase heads, extensive picture and waveform monitor switching facilities, and long-life "Alfecon II" headwheels.

The TR-61 can ideally serve as the master recorder for the TCR-100A Cart Machine, resulting in substantial savings in signal-processing equipment. And it provides another recording and playback source as well.

**"...so much  
machine for the  
money..."**

Versatile, economical, a real workhorse...the TR-61 is so much machine for the money, you owe it to yourself to consider it for any expansion plans you may have.

## **The portable TPR-10. For the production team on the go.**

The trend in RCA broadcast equipment is toward easier portability combined with higher quality, and there's no better example than the TPR-10 Portable Video Recorder.

Only two modules—one the tape transport, the other the electronics—fit together into a space only about 11" high by 24" wide by 13" deep. This fits into the smallest of mobile units and makes an ideal package for all your on-location requirements.

Yet it records full studio-quality color on two-inch tape in quad format. And plays back its 20-minute tapes for immediate verification. Retakes are possible when necessary because full erase facilities are included.

Back at the studio, the tapes can be played back on your regular quad recorders. In fact, a TPR-10 in the field and a new TR-61 in the studio make an unbeatable combination for flexibility and value.

The TPR-10. It's one more useful tool from RCA for the up-to-date broadcaster.



# The TR-600. The next step in video tape technology.



It won't be available until mid-1975, but we're including it here so you can keep it in mind for your future plans. It's a whole new approach to cost-to-performance technology.

It employs built-in automatic features most broadcasters want. It takes full advantage of latest technology. It is light-weight and compact. It promises simplified operation with minimum maintenance. And it will be available at a list price of \$79,500—resulting in a price/performance ratio that will please the most hard-nosed businessman.

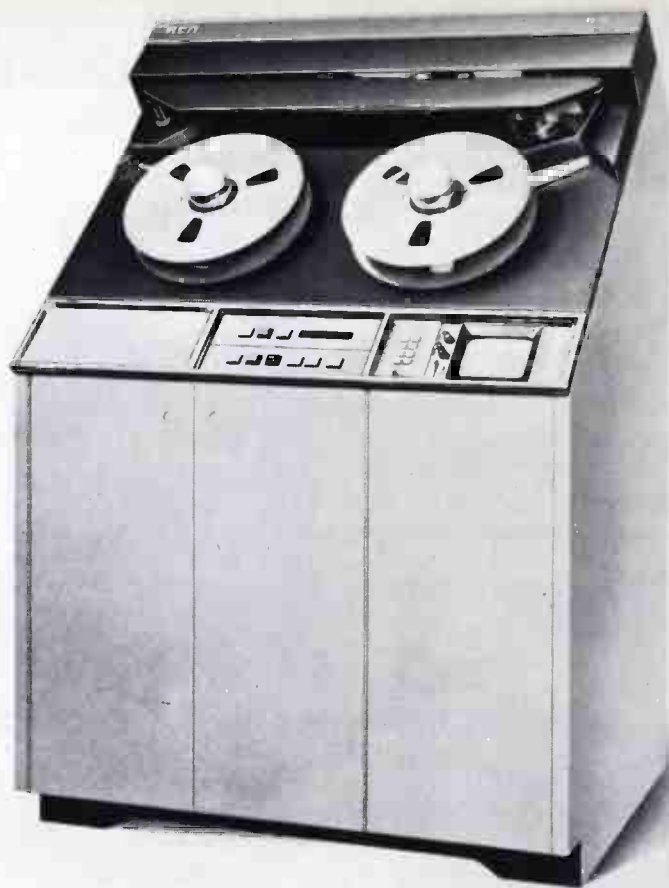

“...keep it in mind for your future plans.”

With RCA...the choice is yours. You select from a complete and comprehensive line of video tape equipment. You make the “money”, “time”, and “use” decisions. And no matter what your choice, we have the recorder for you.

The Quad Recorder	What it has and what it does	Availability	What it costs
<b>The TR-70C</b>	The all-round premium VTR, for wherever utmost quality is demanded. Complete with CAVEC and DOC.	Now	\$103,500
<b>The TCR-100A</b>	The automatic station-break machine that has production uses, too.	Now	\$165,500
<b>The TR-61</b>	The value machine... complete with CAVEC and DOC, fast lockup time.	Now	\$ 75,900
<b>The TPR-10</b>	Portability and performance, mobility and modularity.	Now	\$ 65,000
<b>The TR-600</b>	Quality and compactness, automation and economy.	Mid-1975	\$ 79,500

## CC RULES & REGS

political editorials<sup>4</sup> (i.e., a station's endorsement of a particular political candidate). Again, as with political broadcasts, the broadcaster must operate in the public interest and assume the obligations of the fairness doctrine.

### Participation in Application Proceedings

In addition to the informal letter complaint discussed above, citizens or groups may participate in proceedings concerning new licenses, license renewals, license transfers, etc. The interested citizen or group may proceed *informally* by filing an "Informal Objection" or *formally* by filing a "Petition To Deny."

"Informal Objections" may be made by citizens who do not qualify as "parties in interest" or (2) do not wish to "assume the burdens of parties to the proceedings." The Commission handles informal objections much as it does letter complaints. If the objection is deemed *not* to raise an issue of substantial public interest, it is rejected. The objecting party may then seek review of the staff action by the Commission itself. If the objection is deemed to raise a *substantial* public interest question, it may be dealt with on its merits by the Commission "in conjunction with action on the application."

A "Petition To Deny" is a formal objection to granting an application. The complainant assumes a heavy burden and becomes a party in the proceedings. Thus an informal objection may be more attractive to a potential complainant concerned with conservation of time, money, and effort. Broadcasters should note that the "Petition To Deny" must allege injury to the *public interest* rather than to the *complainant's* interest. Complaints failing to conform to the former standard are treated

as "Informal Objections."

### Rule Making

The final method by which citizens or groups can confront broadcasters at the Commission is by filing a "Petition for Rule Making." For example, a complainant whose informal objection to a particular license renewal proceeding is rejected can institute a rule-making proceeding to "codify" his position on the issue of his concern.

In response to the rule-making petition, the Commission will issue "(1) an order amending the rules, as proposed or modified, or (2) a notice of rule-making proposing amendment of the rules, as proposed or modified, or (3) an order denying the petition."

Conversely, a citizen or group seeking to force a broadcaster to act at variance with Commission rules may file a "Petition For Waiver" of a rule. The individual bears the burden of convincing the Commission that the waiver is justified on (1) "public interest grounds" or (2) "grounds of hardship or undue burden."

### Conclusion

Broadcasters must be aware of *how*, *when*, and *why* citizens and/or groups may confront them at the Commission. The sanctions which attend successful informal letter complaints, informal objections to application proceedings, "Petitions to Deny," and rule-making petitions, dictate that broadcasters pay close attention to everyday station operations and programming. Some advance planning and simple recognition of potential program and operational problem areas may obviate unpleasant and expensive confrontations with the Commission.

BM/E

<sup>4</sup>"Notice and offer of reply time" must be sent within 24 hours of the editor's broadcast. See Section 73.123(c) of the Commission's Rules and Regulations.

# EVERY PRODUCT WE MAKE... MAKES YOURS LOOK BETTER

IMAGE ENHANCERS

VIDEO PROCESSING  
SYSTEMS

TIME BASE  
CORRECTORS

SYNC  
GENERATORS

TEST  
EQUIPMENT

DISTRIBUTION  
AMPLIFIERS

PROGRAM SWITCHER  
SPECIAL EFFECTS  
GENERATOR

EDITOR PROGRAMMER  
AUTO CONTROLLER



**DYNASCIENCES** | video products

TOWNSHIP LINE ROAD • BLUE BELL, PA. 19422  
Telephone: (215) 643-0250 Telex: 84-6358

Circle 186 on Reader Service Card

# NAB Show-In-Print '74

## Competition in all categories added up to rich choice of equipment

- Pervasiveness of digital circuitry page 25
- Quad counters helical threat page 25
- A plethora of time base correctors page 30
- The super TBCs at the 1974 NAB page 32
- Electronic journalism, cameras and systems page 32
- A new studio camera page 36
- TV studio lighting and accessories page 37
- New production talent from new production switchers page 37
- New video distribution system page 40
- Assorted video equipment plentiful page 40
- Character generators: another flood gate opened page 42
- Video editors: simpler or more complex page 46
- Videotape "breakthrough" announced page 46
- Film: as news gatherer, program source page 48
- Choice in radio automation page 50
- TV automation—no stampede page 54
- Business automation systems strong page 56
- Transmitters: more choice page 56
- Digital peak-reading monitors; test gear page 62
- Consoles; other audio equipment page 78

Competition, lots of it, marked the 1974 NAB Exhibition at Houston. It all added up to a rich choice of products and features for the broadcaster. If you were in the market for a new broadcast videotape player, for example, you had a new supplier to consider: IVC and its new segmented helical recorder, the IVC-9000. IVC offered a superb picture in the \$70-90,000 range and a tape savings of 50% since tape speed was 8 ips. But IVC was not alone in offering lower cost tape recorders. RCA, having a favored exhibit area right at the entrance, was able to get on base right away with the crowd and took some of the bang out of IVC's thunder by showing a TR-70C modified to operate at 7½ ips without any sacrifice in quality. On top of that, it revealed, for 1975 delivery, a brand new quad: the TCR 600, sharply reduced in size and weight and at a new low price, \$79,500. But it was Ampex that got to third base by unveiling on the floor a production model of its answer to IVC's competition, a modularized AVR-2, lower in cost, size, and tape usage. More about these units in a moment.

Competition was rampant in other areas. There was an avalanche of time







He told NAB board members he favors 5-year renewals, private enterprise in broadcasting and copyright for cable TV.

correctors—eight on the floor and more promised. And 1974 was the year that electronic journalism popped up in every aisle. Ten systems were on display.

Production switchers was another competitive scene with last year's front runners Central Dynamics, Grass Valley, Sarkes Tarzian and Vital, pressed a new unit from RCA, a custom approach from Visual Electronics and growing competition from Richmond and American Data and others once thought to be merely suppliers to the TV market.

Transmitter competition was heightened with the entry of two sources: McMartin with a 1 kilowatt and Sinter with a full line of AM and FM transmitters.

And, there was much competition to be seen—almost too much to count—in the audio area of consoles and open reel tape machines. We'll look at some of the features of competitive equipment in later sections of this report. To keep the broad picture in perspective, it should be noted that a great deal of the new-found choice for broadcasters comes about because of the competitive opportunity offered by the availability of inexpensive but reliable integrated circuits and many clever engineers able to exploit digital technology.

**Pervasiveness of digital circuitry**

The pervasiveness of the importance of digital circuitry was apparent throughout the 100,000 sq. ft. exhibition area:

• Six of the time base correctors offered, operated on the principle of converting analog signal to digits for corrective control (and then back to analog).

• The new Ampex AVR-2 VTR used a newly expanded A/D/A time base correc-

- Two new synchronizers unveiled at the show for quickly locking and intermixing non-sync signals to station sync (a first) were made possible by superior A to D converters.
- Eye boggling production switchers featured digital effects. Those that didn't, used digital logic control.
- Bulky cabling, usually associated with routing switchers, was eliminated as a result of digital control that could switch remote cross points.
- New direct reading AM modulation monitors introduced by McMartin and Belar used digital techniques.
- A digital approach to measuring antenna phase (Delta) was shown; every transmitter on display boasted of remote control capability and, the latest remote control systems (Moseley, Marti, McBee), exploited digital techniques.
- A new advancement in character generator capability (lots of graphics) was possible through the use of a digital computer and digital recording on floppy discs.
- Lower cost videotape editors were on display thanks to low cost digital technology.
- TV cameras and other equipment offered automatic features, again due to smart use of memory and digital logic.

It was only in the audio area that digital concepts had not made a dent—except as a control technology for operating switches automatically.

**Quad counters helical threat**

Last year at the 1973 NAB Convention, it was apparent that the pre-eminence of quad as the sole format for broadcasters was being threatened. In-

expensive time base correctors on exhibit showed how it was possible to get quad stability from low-cost helical recorders and IVC revealed that the IVC-9000, a helical-scan VTR and superior to quad, was on the way. (First units were slated for delivery in Europe since the new system met European demands completely, i.e., two audio tracks and lower tape costs). IVC also showed an automated broadcast cartridge machine, the BCR 200, based on a helical format. In 1973, IVC boasted, "just wait til 1974."

In 1974 at Houston, IVC did indeed show that the IVC 9000 was a superb picture reproducing machine at the tape conserving speed of 8 ips. That feature coupled with two audio tracks and long-life ferrite heads and other advances, along with a price below \$90,000, was enough to turn engineer's heads, even if it did mean considering a new standard in the station.

But IVC by no means walked away with the show. Both Ampex and RCA made strong moves which turned heads back to quad. As mentioned, RCA showed a TR-70C operating at 7½ ips and said performance wasn't sacrificed because of "improved servo-mechanisms and video head materials" and other advances. RCA also announced and demonstrated a new smallish waist-high quadruplex recorder priced at \$79,500. Identified as the TR-600, the new system claimed top performance with automatic features usually available only as high-priced options. These included chroma amplitude correction, velocity error correction, color drop-out compensation,

continued on page 26



Biggest excitement was Pres. Nixon's visit. President's Houston press conference—and warm reception by broadcasters—is still being talked about. Outside Jesse Jones Hall several hundred peaceful anti-Nixon demonstrators were kept in line by police dogs.

## NAB SHOW-IN-PRINT

single frame splicing, automatic control track phasing, record current optimization, guide servos and reel servos.

The new unit weighs but 700 pounds and it offered one-second lock-up. It could be run at either 15 or 7½ ips. The TR 600 will be available in 1975, RCA said. To further combat IVC's thrust, RCA talked tentatively about how it might offer two audio tracks.

It was Ampex that scored something of a coup. Without advance publicity, Ampex unveiled a modular design studio quadruplex unit. The two-piece system—three pieces if you included a monitor bridge—was designed as a studio unit which could be reassembled to fit portable or mobile requirements. Stripped of some of the automatic features found in the AVR-1, prices started at \$69,000.

Operationally the unit was designed

to run at 7½ ips and 15 ips, and to deliver two audio tracks. Implying that the AVR-2 achieved much of what the IVC-9000 boasted, Ampex said "the AVR-2 studio console is designed to work side by side with standard quadruplex recorder/reproducers in the Ampex tradition. We believe the AVR-2 fits the right needs at the right time."

To get the two audio tracks, Ampex did resort to a compromise: it split the existing audio track. This meant signal-to-noise dropped to 46dB (from peak operating level) on the dual mode but this could be restored to 50dB if Ampex 176 tape (a new formulation) is used (specs apply to both 15 ips and 7½ ips). For single track operation, S/N is 53dB, both speeds.

The total system, electronics, tape transport and monitor bridge, weighs approximately 630 pounds. The transport is 150 lbs., and the electronics module is less than 200 lbs. Any of the modules can be lifted easily by two

people. Power drain is typically 8-10 amps. Fast lockup (one sec, NTSC) was a feature as a result of an extended range time base corrector. The AVR-2 is ready to meet NTSC, PAL, SECAM, and PAL-M standards.

As the companies vied on the exhibit floor to draw attention to their new solutions to broadcast recording, engineers from the three companies came together face to face during an Engineering Assembly on Video Recorders for Broadcast Use. Bert Dann of IVC was successful during the panel discussion in getting across the fact that the segmented-helical format chosen by IVC provided superior audio performance (to quad at 7½ ips) and indeed, that the specs for the IVC-9000 in all other respects were equal to or superior to quad. Both Arch Luther of RCA and Charles Anderson of Ampex defended the position of taking a modified quad approach to avoid coping with a new standard. From the discussion it ap-

continued on page 28



Small RCA TR-600 has many features at \$79,500. Units available in 1975.



Recortec said modify old units for \$8500. Two plus a programmer equals an auto cart.



IVC provided the threat to quad with its segmented-scan 2-in. helical unit.



Segmented-scan vs. quad was "debated" by Anderson (Ampex), Dann (IVC) and Luther (RCA). Moderator was Herlihy.



Inside view of Ampex's mod quad, the AVR-2.

# New Scoopic 16mm cameras and lenses. From Canon.

When you're shooting news and documentary footage on location, surprises are no fun. You've got to be ready for anything, with equipment as tough—and as light—as you are.

Scoopic cameras and lenses are exceptionally good solutions to any problem. They are lightweight and unusually versatile. They are designed with human engineering in mind, so they handle easily and operate naturally. Perhaps even more important, for equipment of such precision, Canon Scoopic cameras and lenses are utterly dependable in demanding everyday use.

Nothing will prove to you how good Scoopic 16mm equipment is as well as the equipment itself. Visit your local authorized Canon dealer for a demonstration. Or write directly to Canon for more information today.

## SCOOPIC 16M

This is the professional 16mm camera that's perfect for fast-moving news and documentary work. New, brighter-than-ever viewfinder also gives you TV safe-frame markings, T-stop scale, and under- and over-exposure warnings. Exposure control is automatic or manual, at your option. Filming speeds range from 16 to 64 frames per second, plus single frame. Battery power runs 12-volt rechargeable NiCd cells you through 1600 feet of film at 24 fps on a single charge. Fast f:1.8 Canon Macro Zoom lens with 6:1 ratio (12.5 to 75mm) and built-in macro capability, for focusing from as near as 3½ inches in front of the lens.

## SOUND SCOOPIC 200SE

All the compact mobility and handling ease of the 16M, with sound, too! Automatic gain control (AGC) assures no volume



Sound Scoopic 200SE

Scoopic 16M

overloads even under extreme conditions. A special rotating mirror transmits brilliantly bright images to both film plane and viewfinder. Zoom lens has 6:1 ratio and allows filters to be inserted through external filter slot for faster changes with no screwing around. Registration pin for perfect framing, with TV safe-frame markings visible in finder and auto/manual exposure control.

## C10x12 MACRO ZOOM LENS

Canon's exclusive ability to manufacture fluorite and incorporate it into lenses of superb quality and light weight is seen at its best in this phenomenal lens. Zooms from 12 to 120mm for a 10:1 ratio, with chromatic aberration reduced to near

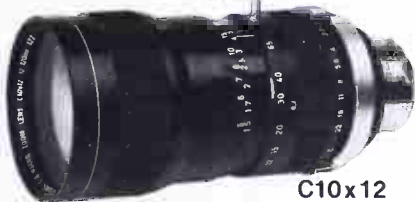

C10x12

theoretical limits. Macro focusing begins at a phenomenal .04" from lens front. Use of macro ring and focusing ring plus zoom allows you to produce effects heretofore

possible only in the lab. Fast f:2.2 maximum aperture, with optical performance that rivals prime lenses.

## C6x14 ZOOM LENS

This is the first lens ever to be designed specifically for the new Super 16 format. Upholds all the famous Canon standards for lens quality, with fast f:2 max. aperture,



C6x14

unsurpassed sharpness, contrast, and color accuracy. Zooms from 14 to 84mm for a 6:1 ratio. Well balanced and light weight, the C6x14 is an ideal lens for a wide variety of location assignments.

# Canon®

Scoopic Division

Canon USA, Inc., 10 Nevada Drive, Lake Success, New York 11040  
 Canon USA, Inc., 123 East Paularino Avenue, Costa Mesa, California 92626  
 Canon Optics & Business Machines Canada, Ltd., 3245 American Drive, Mississauga, Ontario

Circle 117 on Reader Service Card

## NAB SHOW-IN-PRINT

pears Ampex is committed in the near-term future to rely on the AVR-2 as its answer to economy. In coming out with the AVR-2, it leapfrogged RCA which announced the TR-600 for '75 and Quad-1 as a concept (which, among other things, proposed a wider audio track for splitting or multiplexing to achieve stereo, adding pilot tone and higher coercivity tape). No doubt because Ampex issued at the show a position paper on quad arguing against certain RCA proposals, the latter clammed—up on Quad-1. There was talk that RCA would issue its own position paper on the subject, but none was available to BM/E when this report was written in late March.

So while Ampex and RCA headed off a number of the reasons for considering the IVC-9000 as a logical investment, IVC appeared unfazed. It claimed to be pleased with 1) the recognition by quad leaders that quad had shortcomings 2) the confusion that re-

sulted because of separate Ampex/RCA tacks. IVC said acceptance was good: it has six machines installed in Europe with back orders for 44 more. Systems have been sold to U.S. customers (no names, yet) and the first of these will be delivered before July of this year. This year IVC did not show its automated cartridge player, but said this new format is moving ahead and that customers will get delivery in 1975.

Major focus in the VTR area was, of course, on the top-of-the-broadcast-line systems. Both IVC and Ampex were also showing the best of their one-inch helicals. Ampex had a new model, the VPR-7950A, which had unusually good stability by virtue of a built-in digital time base corrector—also announced as a stand alone unit (the TBC-800). Since the TBC features a wide correction window ( $\pm 1$  H), the machine could lock up in four seconds and stability was equal to that of quad. This unit was priced at \$31,480.

RCA showed a man-portable quad tape transport for remote work. There

were many portable helical cassette-type VTRs on display, not so much for direct sales, but as adjuncts to electronic journalism systems. (See section on electronic journalism).

Although the big news in VTRs were the new quad models, both Ampex and RCA announced advances in their respective cassette and cartridge players. Both announced that the players could interface directly with computers for direct control by a computer. Ampex ACR-25 was actually operated from a computer in Central Dynamics booth. A system for automatically mixing videotape and film cartridges was shown by RCA. The sources were the TCR-100 videotape cartridge machine and the TCP-1624 TV film cartridge projector. The programmer for this was known as the TAC-1.

Meanwhile, just outside the main VTR "theater of war," stood Recordec, Inc., offering to save broadcasters from the necessity of making an instant choice between the new quad and the new super-helical. While the dust

continued on page 3

## FCC Chairman Wiley Calls for New Trust and a New Ethic

Extending the right hand of openness, if not fellowship, Wiley told delegates that it has been and will continue to be his objective to break down the wall of mutual suspicion, distrust, and fear which inadvertently has divided the FCC and its licensees. He called for candor without fear of regulating reprisals so that regulation of broadcasting would be "intelligent, pragmatic, clear-cut and adequate but not excessive in terms of what the public interest may require." He also said that broadcasting is diverse and pluralistic and promised to keep in mind that special rules for small broadcasters might be the answer.

To keep the dialogue flowing between the FCC, broadcasters and the public, Wiley announced the first of a series of FCC regular meetings "to take the government out of Washington and back to the people where they live." The first of the meetings will take place in Atlanta, Georgia.

Wiley promised efficiency as chairman and said current staff vacancies with FCC would be filled promptly. Apparently fearful that he might be labelled too much of a nice guy about not wanting to be earmarked as a tough guy, Wiley sought a stance of a chairman who would have courage to meet the issues promptly and deal with them fairly.

Wiley did promise to come down hard on those engaged in "unsavory business practices" and he spelled out several: fraudulent billing, rigged contests, hoax announcements, misrepresentations to the FCC and unauthorized transfer of ownership control. "Let me assure you," Wiley said, "I am just enough of a moralist and an activist to see to it that fraud doesn't pay."

Wiley said he would not hesitate to have the FCC undertake corrective action even if he thought the regulation personally undesirable, if broadcasters didn't respond to a "well-documented public need."

Wiley said he would never arbitrate media truth and objectivity, did not want to be the keeper of the national morals, did not want to be the protector of youth, did not want to dictate employment practices, or determine programs. The answer to excessive violence, indecency, the quality of children's programs and fair and tasteful advertising lies with broadcasting, Wiley said. But, he added, the government would have to move in if broadcaster's as the public trustees "avoid their fiduciary responsibility and subtly renounce their proxy relationship to the community at large . . ."

Wiley said he was really calling for a New Ethic "which refuses the extra dollar when the cost is to the public; a New Ethic which reflects a rededication to principle, a rededication to excellence, a rededication to decency, a rededication—indeed—to the public service."





## **MASTERS OF VERSATILITY**

MASTERS OF VERSATILITY? Because they're the full capability consoles SPOTMASTER. They've been developed for the most discriminating Broadcaster — and they allow programming changes without console obsolescence. They're not loaded with options. All important features are built-in — and at a reasonable price. Features like switchable input levels, push button input preselection, identical program and audition outputs, built-in monitor, headphone and cue outputs, internal cue speaker and separate mono matrix outputs in stereo models.

There are nine SPOTMASTERS OF VERSATILITY to choose from — including five eight channel mono and stereo models. Construction features integral power supplies, plug-in modular electronics, and electronic switching with field effect transistors.

*Spotmaster*®

BROADCAST ELECTRONICS  
Emways Company

8810 Brookville Road, Silver Spring, Md. 20910  
Phone 301-588-4983

## NAB SHOW-IN-PRINT

settling, said Recortec, why not let us rebuild your old quad machines, for about \$8500 each, installing our Controlled Tension Modification? The rebuilt machine offers no-stretch tape handling, remote control operation, electronic timing, fast 360-ips search, and improved head and tape wear characteristics.

Recortec also introduced an electronic unit, the Video Tape Programmer, which can be combined with two upgraded quad machines for an automatic "spot" system. It provides some of the operating efficiencies of the automatic video cart machines at around one-tenth the cost. The system works this way: the programmer searches for, and plays on start command, the first spot from VTR "A". While that is on the air for as little as 30 seconds, the programmer has searched for and cued up the second spot in the fast-search mode on VTR "B". At the end of spot 1, spot 2 goes on the air automatically, and the programmer immediately shifts to find and cue spot 3 on VTR "A", and so on. Circuitry is built in to add a third VTR for last-minute additions, if

that is wanted.

### A plethora of time base correctors

Last year there were two makers and this year there were nine—the time base correctors really poured in. Television Microtime and Consolidated Video Systems, the old originals, were of course on hand: CVS with its CVS-504 "universal" digital corrector for "all non-segmented helical VTRs," and TMI with its family of "optimized" units. Most of the new entries were "digital" in that the analog signal is converted to digital for processing. The trend to digital stems from the ability of such units to handle wider windows. TMI which has, heretofore, done all of its video correction at video baseband frequencies, announced it would expand its line to include such digital units. Its new 600 Series of digital units will be ready in fall 1974. More on it later.

The newcomers were: Ampex, with the TBC 800, a digital unit due in 60-90 days with a price in the \$10K - \$15K range; 3M, another digital corrector, with similar price and delivery promises; IVC-Quantel, an English-made digital machine, the TEC-2000, promised for 60-day delivery at \$14K; CBS

Labs, the Model CLD-1500, a \$15K unit (approx.) due for fall 1974, with digital operation; Lenco, a \$3500 corrector, specs and delivery not yet established; Kansas State Network, the "Signal Master," an analog unit, price \$2950, aimed mainly at CCTV and cable; and Dynasciences, with the Model 5000, \$6K, due in 90 days, an analog (binary delay line) unit.

The units with a lot of capability used the pitch at the show "dub up to broadcast" or "do direct broadcast" from helical VTRs. Those with more modest claims, improved, at the very least, CCTV productions.

Naturally, with so many different approaches there is emerging some competitive technology, and we will need a couple of years of trial to get it into perspective. Must a TBC detect errors line-by-line (TMI, Ampex, Dynasciences) or can detection be on an "averaging" basis without letting too much error through (most of the others)? Do some techniques permit a faster lock up time than others? Have all digital designs handled the admittedly difficult noise problem? There are undoubtedly a number of other equally basic questions that will come forward as the new makers get their products on



## Series 70 Recorder/Reproducers

### When you've got more talent than money

TASCAM Series 70 recorder/reproducers were designed for people who've outgrown high-end consumer audio products but can't afford full professional studio gear.

Whether you need single, two or four channels, you define the Series 70... it doesn't define you. Your choices are expanded, not restricted, without paying a performance penalty.

The versatile Series 70 electronics come in two versions, one for direct recording and one for use with a mixing console like our Model 10. Whichever you need you'll get uncommon quality and reliability. But this time you can afford it.

Series 70 recorder/reproducers. When you've got more talent than money.



Circle 114 on Reader Service Card

market.  
 At the NAB show it was not easy to handle on the precise significance of the differences of the TBCs shown. Although it is convenient to separate them into classes of analog or digital with the implication that digital is better, TMI was distributing a technical brochure that showed analog systems used a lot of digital circuitry and CVS's digital units used an analog frequency clock for tracking sync and other variations.

An enumeration of the same major features boasted by various manufacturers for top-of-the line products will make comparison an easy matter (I/E will try that in a future issue), some idea of what must be considered in an evaluation emerges.

TMI, for example, in announcing the DC series, said the design would minimize the effects of digitizing error, quantizing errors and heterodyne processor noise common to other designs." The unit will also compensate for velocity errors detected at playback of direct recorded signals, it said. A 9-bit binary equivalent was discussed to achieve good resolution.

The CVS 504, was in a sense, the standard from which comparisons were made. Its window is listed as greater than  $\pm 1$  horizon line (more than 180 microseconds). It talked about a stability of  $\pm 4$  nanosec for direct color but qualified this as average over 360 degrees at color sub-carrier (and using energy tape). For a capstan servo decoder, stability is listed as h-lock or 2.6 nanosec. Lock time for color is less than 2 seconds (typically) for a servo or less than 1 millisecond if a external lock is supplied. The CVS unit, of course boasted that it was ready to work from any helical, with or without color. It would also work from direct color or heterodyne color. Such capabilities were shown dramatically in the booth as it dubbed non-servo units through an interface unit up to quad, mixed with special effects, etc.

Ampex called its TBC-800 unit a 6th generation TBC with all of the inherent advantages of a digital system. The unit was of unusual interest because the techniques used were incorporated into two new VTRs in Ampex's booth, the AVR-2 and the 7950A. It offered a wide correction window of 10 lines (equalling 2 lines) and a color output stability of  $\pm 2.5$  nanosec. The unit works with capstan-servoed helical.



Super TBC from NEC/TeleMation locks any remote to station sync in one frame.



CBS Labs shows off its digital TBC.



Ampex announced stand-alone TBC.

Ltd. design) boasted a 192 microsec correction range or the equivalent of three horizontal lines. It claimed  $\pm 4$  nanosec stability in the burst locked mode or  $\pm 25$  for horizontal locked mode, assuming a good S/N ratio.

CBS Labs stressed random access memory for instantaneous correction which it said was less than three horizontal scanning lines for color. Stability was given as  $\pm 4$  nanosec with 40 dB



Television Microtime showed a full line of TBCs.



CVS showed how universal unit could dub any helical to quad.

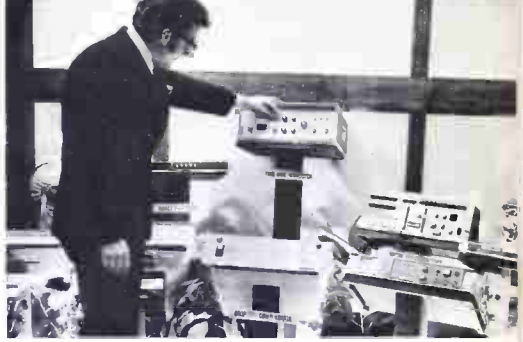

3-M had new digital TBC.



Less expensive unit shown by KSN.

S/N or 20 nanosec monochrome. It talked about an 8-bit sampling rate (as did most other manufacturers except CVS), as necessary to preserve picture data and resolution.

The 3M DP-100 unit appeared to be similar to others but its spec sheet tended to use a slightly different language. Its main sales pitch was that it had built-in processing with a full set of controls all on the front panel. (Proces-

continued on page 32

## NAB SHOW-IN-PRINT

sing was offered by others, but sometimes as an option).

One thing we can take now as highly probable: a shake-out in the field in about two years, with one or two low-priced, one medium priced, and one or two high-priced correctors becoming solid.

### The super TBCs at the 1974 NAB

An extension of video signal correction techniques used in TBCs leads to another very useful device. A Digital Video Synchronizer is what CVS called its unit. Over at TeleMation's booth, a similar system developed by Nippon Electric Co. Ltd, was referred to as a frame synchronizer.

What these developments mean is that if you have an incoming signal such as a remote or a net feed, you don't have to fade to black while you bring local genlock circuitry into phase coincidence with the remote source. Neither do you have to use ultra-stable timing references such as rubidium standards to guarantee stable color phasing—which may not work anyway if the path length changes as a result of

extremely long land lines or the use of a satellite. And in any event, there has to be a feedback circuit available to "talk" the signals together.

As TeleMation describes it, "The use of a frame or field synchronizer eliminates problems associated with genlock and rubidium standards operations. It provides almost instantaneous 'lock-up' to an external asynchronous source, with no disruption of local sync timing and no requirement for controlling the horizontal, vertical, or sub-carrier phase relationships between the two signals." At the CVS booth, non-synchronous feeds were taken from other booths and intermixed (even in a quad split) with CVS-generated material without a noticeable glitch. The CVS system would lock up to the first field occurring. The Nippon Electric Co. unit would lock up to a field or the whole frame since it has enough memory to store both even and odd fields. The frame synchronizer provided a perfectly smooth transition whereas the field-type synchronizer requires a fraction of a second to achieve stability.

Both of the new systems operate similarly; the video is digitalized and stored in memory. The station sync provides the reference signal for clock-

ing out (reading out) the stored video input which is then converted back analog. The retrieved picture is in frequency and phase coincidence with local reference source.

In both units the video signal is divided into 8-bits (at a 10.7 MHz rate) that identifies one of 256 voltage levels. The CVS unit is priced at \$37,500. The unit from TeleMation with faster lock-up is in the \$100,000. range.

### Electronic Journalism cameras and systems

1974 was the year that electronic journalism systems came to the fore—ten such systems could be counted on the exhibit floor. In previous years more than two or three hand-held shoulder-supported systems were displayed. Last year, for example, the only new contenders with working models were Editel and Asaca, though both Fernseh and RCA showed demonstration units. Before that, it had been almost exclusively a Philips show with the PCP-90 as the only broadcast-quality miniature available.

This year, at Houston, it was different: there were four major broadcast camera manufacturers showing electronic

continued on page



For further information, please write to:

**cinema E products**  
CORPORATION

Technology in the Service of Creativity  
2037 Granville Avenue, Los Angeles, California 90025  
Telephone (213) 478-0711 ■ Telex: 69-1339 ■ Cable: Cinedevco

## PLC-4 Magazine

From Cinema Products — the newest, most advanced design in 16mm 400 ft. magazines.

### FEATURES

- Made of extremely lightweight, glass-filled Lexan®, a material with greater impact strength than magnesium, the molded plastic PLC-4 magazine completely eliminates the problem of film spotting (caused by particles of magnesium adhering to the emulsion and reacting in the developing bath).
- Compartment-type magazine design permits the use of either 200 ft. or 400 ft. darkroom cores or daylight-load spools.
- Hinged magazine doors provide quick access for fast loading and unloading.
- A triple-step light trap on doors prevents light leaks.
- Magazine toe is a removable aluminum insert, easy to repair or replace.
- Magazine may be fastened to the camera by conventional screw-down methods or the unique Cinema Products snap-latch technique.
- PLC-4 magazines are extremely silent in operation.

### MAGAZINE COMPATIBILITY

PLC-4 magazines are compatible with all 16mm camera systems which accept standard 400 ft. Mitchell-type magazines.



PLC-4 Magazine shown with CP-16R Reflex Camera.

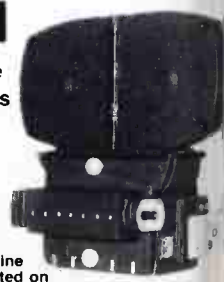

PLC-4 Magazine shown mounted on Auricon Cine-Voice Camera (400 ft. conversion model).

Circle 112 on Reader Service Card



# TeleMation's TCF-3000 color film camera

ually-  
color  
m chain  
ersatility!



TCF-3000 Color Film Camera gives you:

- 1. Dual Input with Internal Diplexer
- 2. 4 Positions of Input Port - Interface to All Film Systems
- 3. Fast Attack ND Light Control
- 4. Auto Black - Auto White
- 5. Highest Quality Prism Optics
- 6. Perfect Color Tracking - Passes PAL phases of the SMPTE color test film
- 7. 2-line Aperture Corrector with comb-filtering
- 8. 6-vector Color Corrector with Presets

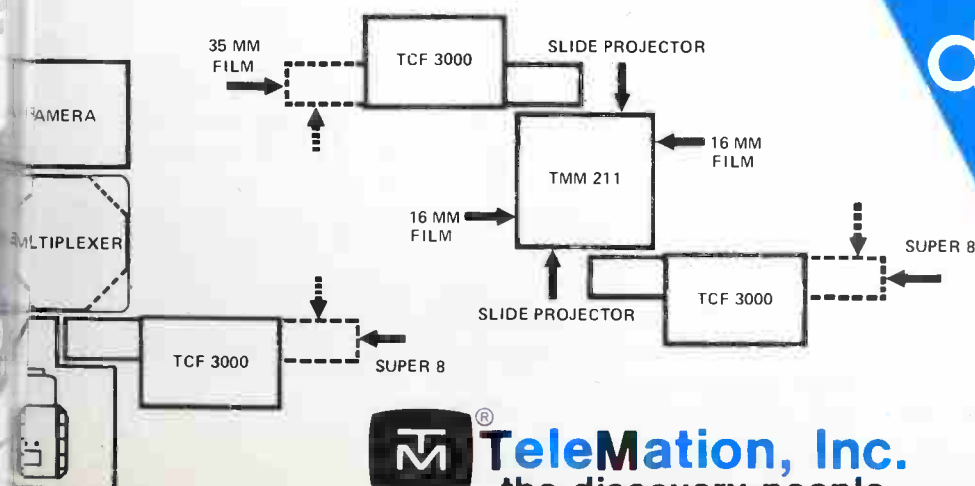

discovery  
'74

 **TeleMation, Inc.**  
the discovery people

P.O. BOX 15068, SALT LAKE CITY, UTAH 84115

Circle 118 on Reader Service Card

## NAB SHOW-IN-PRINT



The Marconi Mark VIII-X portable.



Fernseh portable covered Nixon appearance.



Norelco PCP-70B works with studio units



Hitachi's unit fed a portable Philips VCR unit.



CEI surprised convention with portable.



Ikegami unit is used by CBS News



RCA's TKP-45 in action.



TeleAlpha system played back Sanyo cassettes.

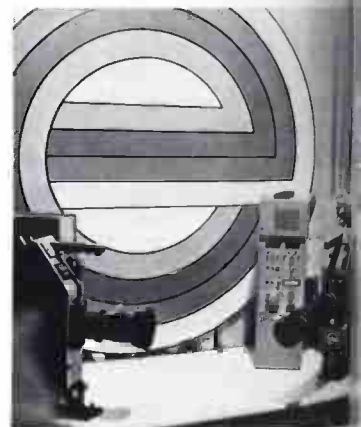

Editel showed ENC camera for news

tronic news gathering systems and a host of independents. In the first category fall Fernseh, Philips and RCA, joined this year by Marconi. In the latter are Asaca, Commercial Electronics Inc., Editel, Hitachi Shibaden, Ikegami and TeleAlpha.

Major broadcast camera suppliers offered camera heads that are fully equivalent to studio cameras and, in fact, are interconnected to standard camera control units located back in a mobile van or studio base. Philips has

carried this integration the furthest. It has standardized on a universal shoulder-mounted camera head configuration. The head is connected to various hippack/backpack alternatives which in turn feed corresponding standard camera control units. This year Philips introduced the PCP-70B, thus permitting the many stations now using PC-70s to now add a portable field camera to their complement. Philips expects to have a PCP-100 unit soon. Since it has already had as

PCP-72 backpack unit, both its new and old customers are served. (The PCP-90 head unit fits this pattern to but it has always required a separate base station control unit).

The PCP-70 introduced this year weighs less than 15 lbs. (before lens and the "mini" hippack less than lbs. Up to 2000 feet of cable can be used. (For comparison, digital controlled camera heads, the PCP-70 and PCP-100, can use triax cable

continued on page

# SUPER 8 IS HERE.

The new KODAK SUPERMATIC 8 Processor lets almost anyone on your staff get expert film processing results.

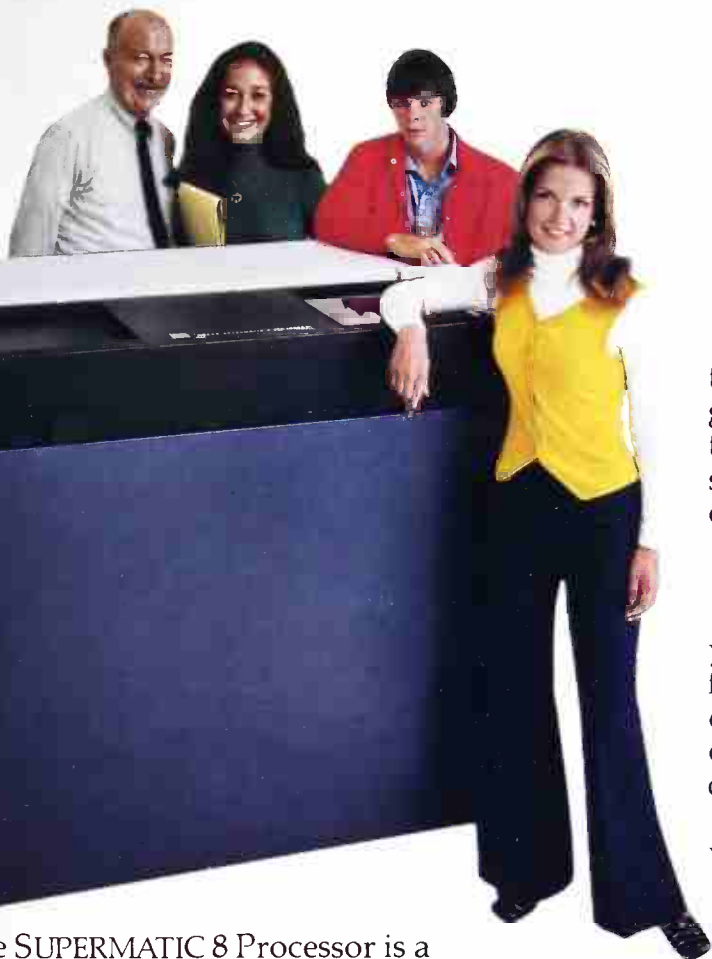

the push of a button. And a little light goes on to tell you when it's time to push the button. Automatic threading and no special plumbing installation...just an ordinary tap and drain will do.

It all boils down to this: Super 8 film is economical. Our new KODAK SUPERMATIC 200 Sound Camera gives you the portability you need for local features, news and commercials. With quality thrown into the bargain. And our new SUPERMATIC 8 Processor develops your film fast.

Take a closer look. Take advantage of easy super 8.



The SUPERMATIC 8 Processor is a complete film processing lab in a cabinet-size unit that virtually anyone can operate. It features a rapid-access operation that processes a 50-foot roll of the new KODAK EKTACHROME SM Film 7244 in just 13½ minutes.

And it's so easy to operate.

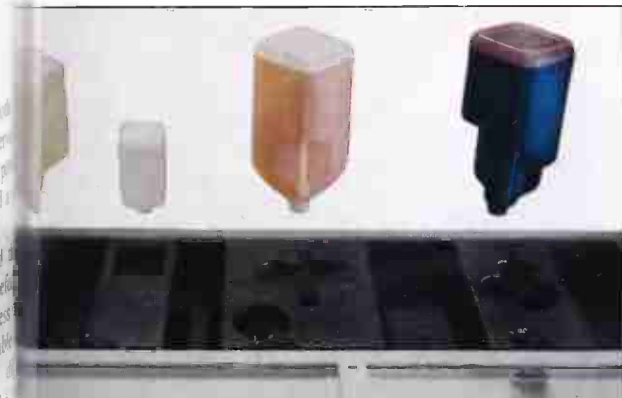

The chemicals come in color-coded bottles that fit only in the proper slots. It automatically flushes and cleans itself at



Please send me more information on all your new professional super 8 products, including the new KODAK SUPERMATIC 200 Sound Camera, pictured here.

Return this coupon to:  
**Eastman Kodak Company, Dept. 640-PR**  
Rochester, New York 14650

Name \_\_\_\_\_

Address \_\_\_\_\_

City \_\_\_\_\_

State \_\_\_\_\_ Zip \_\_\_\_\_

## NAB SHOW-IN-PRINT

5000 foot extensions. The former can also use microwave.)

RCA's new TKP-45, a 20 lb. shoulder-mounted unit (with a 6x zoom lens), features many automated performance features. Thus the cameraman can concentrate on composing pictures rather than making adjustments. For example, the TKP-45 includes Chromacomp color balance, automatic lens iris, scene contrast compression and bias light. It can operate up to 1500 feet from the CCU.

Fernseh's answer to electronic journalism is its KCR unit which is part of the family of KC cameras. One of Fernseh's cameras was put to use covering President Nixon's visit to Houston. The backpack contains an automatic processing amplifier and batteries. Fernseh offers several options for getting the video signal into the broadcast system: via microwave link, with a second man carrying the microwave transmitter; via cable (triax); or via recording on a portable recorder, (carried by a second man).

Marconi's unit unveiled at the show is part of a family. It was dubbed the Mark VIII-X.

One of the very smallest (and three tubes) electronic camera systems on display was Asaca Corp.'s ACC-5000 which made a hit last year. Its self-adjust and auto-control features make it easy to use. It has a genlock capability which permits it to be used as part of a

system.

Also back again, as mentioned, was Editel. This year the company had, in addition to last year's Mark-III, a hand-held camera designed specifically for one-man electronic journalism. Called the ENC-1 the unit includes three broadcast Plumbicons. It was a complete system in that it could be battery operated. (A triax cable would permit up to 500 ft. extensions). A complete complement of lens is available.

A three tube Plumbicon TV camera that was extremely small, was the Ikegama unit. It included a microwave system in its backpack. This unit has seen use by CBS News on the west coast. Called the Handy-Looky, the unit can operate on a single coax up to 1500 meters from the base station.

A rugged unit that was designed for use by NHK Broadcasting, Japan, was shown by Hitachi Shibaden. The unit uses a special single tube. It was being used with a portable cassette VTR (Philips VCR) to be a complete news gathering system. Through the use of a CVSTBC, the recorder output could be brought up to broadcast standards.

Something of a real surprise was a full broadcast—quality portable backpack unit unveiled by Commercial Electronics Inc. It uses three Plumbicons, or optionally, a silicon diode red tube. The camera was very small by virtue of localing all tubes in a single plane. It was equipped with a 10:1 zoom.

Most of the above systems are in the

\$35,000-40,000 price range for the camera head and control backpack.

One of the most interesting—though not working systems—was shown by TeleAlpha, Inc., a company from Santa Clara, California. TeleAlpha's components were an Akai camera, ½-in. cassette VTR by Sanyo and cartridge playback/editor deck (which the company called a NewsTape Processor). One could play the cassettes directly on air (using a TBC) something like a radio station would play audio cartridges, or the video camera player could be used to preview and edit tapes. Two or three playback decks allow electronic A-B roll editing or sequential play through a programme. The Sanyo cassettes play for 20 minutes and are not much bigger than a 8-track audio cassette. The cassette recorder itself is pocket-sized and TeleAlpha showed a form-fitted molded backpack that held the recorder, battery pack and, which at the same time served as a camera support.

### A new studio camera

Although a great deal of interest was shown in cameras for "electronic journalism," camera manufacturers tried to put their principal emphasis (meaning showmanship) on top-of-the-line studio cameras, as in previous years. This year there was a brand new studio camera that was not only good looking from a point of view of style, but one that produced a good looking picture. We are referring to the IVC-7000. IVC moved out of the medium-priced camera class with the IVC-7000 and it was producing outstanding pictures. Picture noise was not visible. The camera boasted all of the features of other expensive cameras but the selling price was below \$60,000. (This camera plus the high performance VTR, the IVC-9000, put IVC fully in the broadcast league).

Ampex had made some changes to its BC-230 line. It made a point out of instant pictures, i.e., cameras produce full registry pictures from a cold start.

Philips drew some special attention by showing a new experimental low-light-level Plumbicon. High-quality pictures were shown with an ambient light of four ft. candles. Philips was also able to generate renewed interest in the PC-100A, even though it has been a familiar unit at the show for years, by announcing that ABC has become the first major television network to standardize on the PC-100A. ABC said it was buying up to 24 units in the next months. The order came to over \$2 million, not including lenses.



Cohu showed low-cost production center using single-tube camera.

Brand new studio camera was the IVC-7000 featuring unexcelled performance at mid-range prices.



Ampex added automatic features to its BC-230 line.

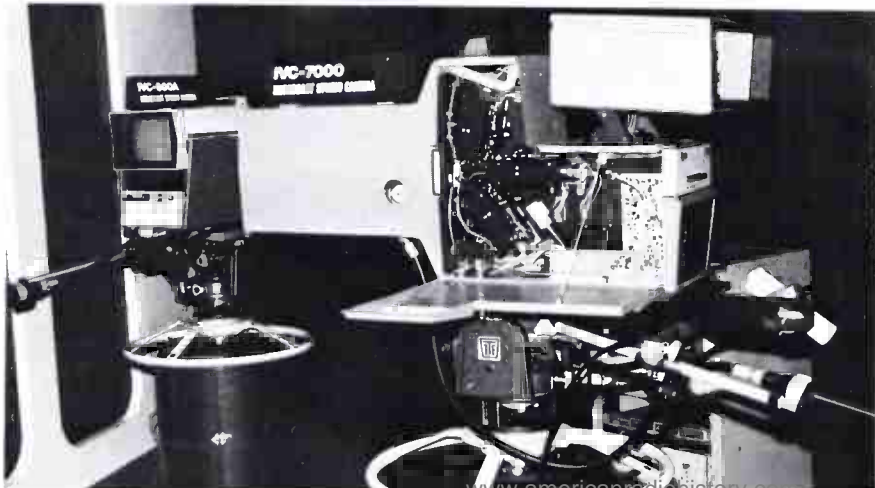



lens gets discriminating examination.



Berkey Colortran had new memory control.



boasted biggest zoom.

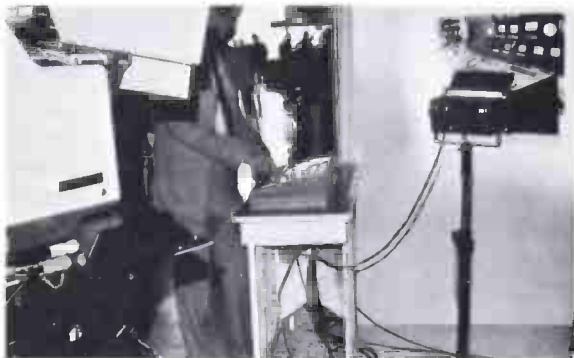

Power Optics showed how to automat pedestal and camera.



's lighting control unit.



Telecommunications' test charts.

... (Hensh and RCA staged elaborate demonstrations to show off their studio cameras. More modest efforts showing more modest (and familiar) cameras were put forth by Cohu, Commercial Electronics, Gates and Shibaden.

The battle front on TV lenses was a bit quieter than last year since all of the big zooms—30x and 34x etc., appeared last year. What intrigued attention almost this year was ease of use and the exhibitors, Angenieux, Canon, Mole-Richardson and Strand Century, got a lot of booth action.

... pedestals to hold TV cameras (from Photo Systems, Innovative TV, Berkey, and Quick-Set), were plentiful, but we didn't spot any significantly new ones. Offering competition to Boston-based Wire in camera cables this year was Mohawk Wire and Cable.

... aid in setting up cameras was provided by Telecommunications Industries Ltd., which had a big range of portable test charts. ... talent in front of cameras were the usual PrompTer systems by Q-TV. ... featured this year was the conveyor

transport the VPS-3000.) To run TV cameras remotely and without a cameraman one could buy from Power-Optics Ltd., a digital control system.

### TV Studio Lighting and Accessories

Much as TV camera manufacturers stressed low light level capability, lighting is a must 99 percent of the time, and on hand to show off such gear were Berkey, Kliegel, Lowell, Mole-Richardson and Strand Century. Lamps were shown by GTE Sylvania.

Berkey and Kliegel stressed, in addition, lighting control systems with memory. Such units have been shown in the past, but advances have been made. Berkey's Memory Center, for example, takes a modular approach and has a microprogrammable controller. Using a flexible Xerox Data System computer, the unit featured extremely fast operational response and the ability to handle up to 2,850,000 commands per second. It could detect its own faults and isolate trouble spots while

scene lighting was being stored in memory. Just in case the TV program did not progress as preprogrammed, override was possible.

On hand offering assistance in studio design, was Imero Fiorentino Associates who were also offering a handy color contrast evaluation kit to determine the grey scale of various set materials.

### New production talent—it comes with those new production switchers

To those attendees who have never run a production board it looked like a lot of razzle dazzle. To those who have had experience, the new boards were marvels. BM/E editors place themselves among the former group and we were often bewildered by what was being done at such exhibits as Sarkes Tarzian, Grass Valley, Central Dynamics, Vital, Visual Electronics and RCA. There were other production switchers on hand too, but these

continued on page 38

## NAB SHOW-IN-PRINT

exhibits were going all out. RCA was even using a computer to create some effects.

Some of the presentations were confusing particularly when the board designer wanted to show something particularly subtle—or fancy—which was really a by-product of the design. So we were especially pleased when we found the literature prepared by Vital to describe its new VIX-114 all Digital-Controlled Video Production System. The book is a masterpiece in explaining what the state of the art is today (a stable electronic approach—through digital techniques—that make it possible to match film production techniques). We began to understand about hard key, soft key, see-through key, edge key, shadow key and outline key. We learned that the Mix-Effects Preset system (that Vital uses) blends key,

wipe and mixing functions in an additive mode to perform unusual functions. And we began to realize that some of what we saw was possible because one could intermix digital effects with wipe and key to any degree one wished. As for digital quad split, you'd have to see it to believe it—it can't be described.

What we didn't understand from Vital's brochure we found in Central Dynamic's equally fine booklet, *On With the Show*. The latter's format was jazzed up slightly but it did have color pictures describing some of the techniques ably described in Vital's material—plus a few more such as cameo/transparent matt picture frame. If you're in the market for a new production switcher, which seemed to be the case for many at the NAB show, get both Vital and Central Dynamic's literature. It will help you to understand what is possible with the products of not only those two companies, but

those of the other leading production switch makers as well. And as demonstrated at the Sarkes Tarzi booth, you can get a board that is custom tailored for you.

If you desire some of the benefits offered by new boards but can't afford the \$50,000-60,000 price tag, there were some consolations. Astrionics (Technicolor), for example, was offering a linear or soft wipe composite picture without halos or scintillating outlines (the feature found in Grass Valley's 1600 switcher) as a benefit possible with its stand alone Chromatech unit. Central Dynamics was offering a similar stand alone unit. American Data had an "OBQS" which stands for one bus quad split (you get quad split effect using no switch bus on your primary switcher).

There were of course, all kinds of production switchers at the show covering all price ranges. Some of the companies included American Data

continued on page

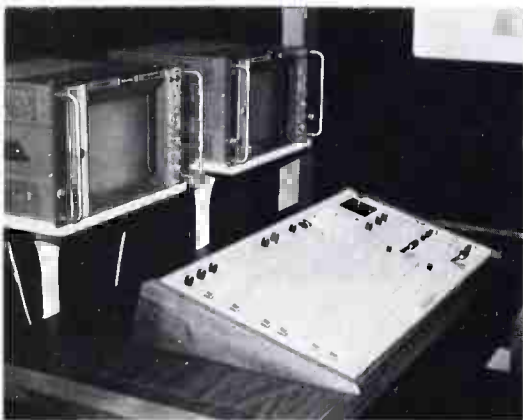

Central Dynamics vsp-1260 video production switcher.

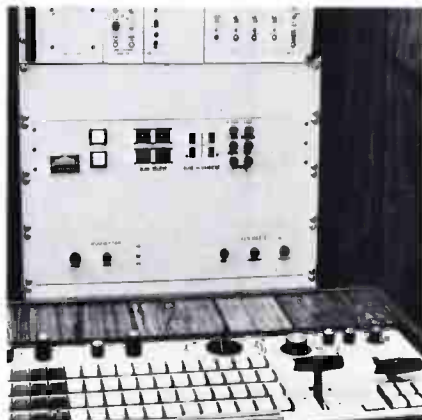

American Data's switcher and one bus quad splitter.



Visual's switcher permitted keyed inserts non-sync remotes while locked to station.

Vital's VIX-114 Digital-controlled switcher was always in use.



Grass Valley production switcher got keen attention.



Far right. Purchaser, KTBS-TV, looks over RCA switcher.



**There are at least 10 reasons why the Audiopak A-2 is beating out the competition. Here is Reason No.1. How many times have you had broken or missing pencil leads in a cartridge flange? Can't happen on the Audiopak. There aren't any! We mold the tape support ribs as an integral part of the flange. There are 9 other reasons: write for our literature and free cartridge.**

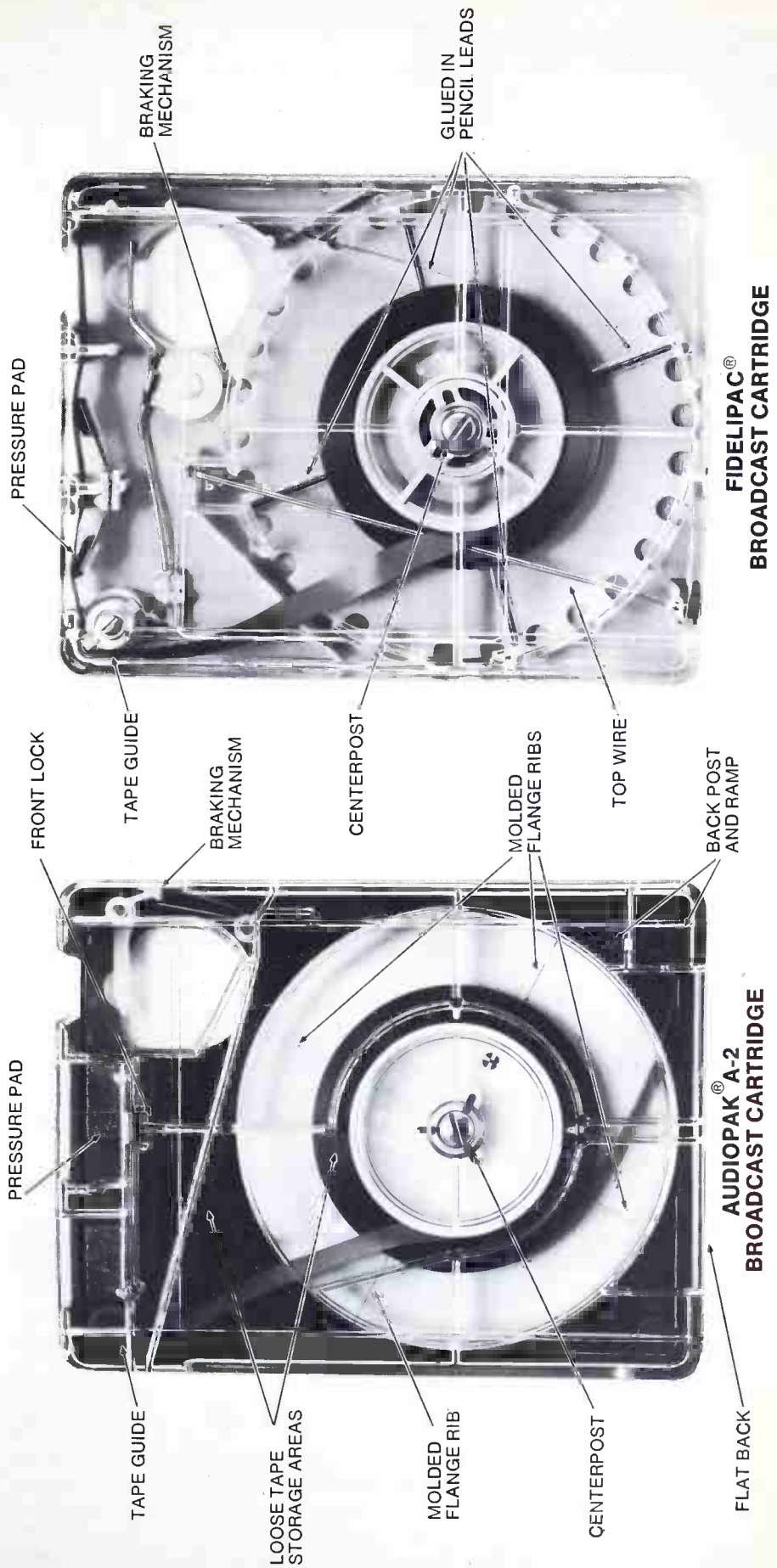

AUDIO DEVICES, INC., A CAPITOL INDUSTRIES CO., 100 RESEARCH DRIVE, GLENBROOK, CONN. 06906 • MANUFACTURERS OF AUDIOTAPE®, AUDIOFILM® AND AUDIODISCS®

Circle 120 on Reader Service Card

## NAB SHOW-IN-PRINT



Andrew transmission line.

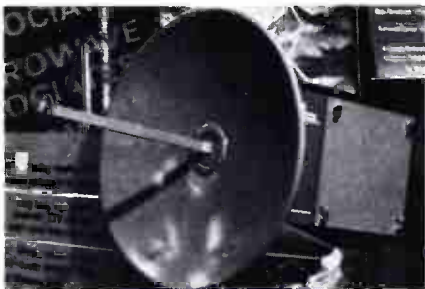

Microwave Associates solid state microwave.

Dynair, Dynasciences, Richmond Hill, Telemet and ISI. Various features were offered by each. ISI for example uses an integrated circuit which is configured as a variable linear attenuator to provide extremely stable transitions.

Dynair offered, for example, a new low-cost-remote-controlled production switcher for non-broadcast use. Dynasciences showed not only its own switchers but those formerly made by Alma.

3M showed a new special-effects generator, SEG-672, providing full complement of TV effects at moderate cost.

### Video Distribution Switchers, Pulse Systems

Routing the numerous audio and video signals encountered in today's broadcasting operations to an ever growing number of studios, production centers, recording locations, etc., has called for the installation of distribution systems. Various system approaches have evolved—many have been custom-built for a particular station and leaders have been CDI., Dynair, Grass Valley, Richmond Hill, Telemet and Vital. (with many others making DA's and other accessories).

This year, challenges came from TeleMation and American Data Corp.

TeleMation announced an "order of magnitude" improvement in size and installation simplification—floor to ceiling racks have been replaced by a single rack chassis, which includes the switch cord, power supply and control circuitry.

Clue to size reduction is a TeleMation packaging approach which puts 100 video or audio crosspoints on a single card (or 1000 in a single rack). Basic card is a 10 in x 10 output configuration. It includes 10 input buffers, 100 matrix crosspoints and 10 latching circuits. The video card has an additional crosspoint at the output of each buss to minimize capacitive loading and crosstalk. Bulky phasing sections have been eliminated by the compact design and internal video interconnection scheme.

Each switch system includes a single Polling and Controlling card which produces 127 different interrogation signals to address as many different control stations. Each station recognizes its own code and responds with "have data" or "do not have data." Interrogation is done 15 times a second. Control stations are 10-key desk top units. System can interface with a computer and is expandable to 100 x 100. Designation is TVS-1000/TAS-1000.

American Data Corp. announced a "breakthrough" by virtue of combining video and audio switching in a single solid state crosspoint. It claimed "unsurpassed individual crosspoint shielding." In the 900 series switching matrix, the single IC discretely switches video, audio and two levels of tally. ADC, too, says new levels of compactness are available. They put 600 crosspoints along with logic and output amplifiers in six units of rack space (10½ in.). A digital logic word of 16 bits can control a 100 x 100 matrix without interface hardware in the ADC system.

Space saving was the theme of Richmond Hill for its routing switcher, the AVM-8000. While the unit was not as compact as the two previously mentioned items, RHL did a very respectable job by getting a 25 in. x 25 out matrix of both video and audio including power supply in 43½ inches of rack space. RHL said crosstalk was -60 dB. Showing a compact routing system for CCTV purposes was Marco Video Systems.

Pulse distribution systems were on display by many companies. An interesting product shown by Lenco was a VP-1 video presence detector which would sense the loss of video or sync,

and switch to an alternate line automatically. Machine delegation control systems were shown by several companies. Both CDL and Fernseh showed new approaches.

### Assorted video equipment

"Improved" as opposed to "new," generally characterizes that host of products that fall into the loose categories of video accessories, video processors, etc.

There were some new items however: Grass Valley showed a new concept in single line pulse distribution system components. The 3250 Series Sync Pulse Generation System (which is digital), includes master and slave sync generators. The master provides genlock facilities. The slave, although intended to operate from a reference signal provided by the master, does have a crystal oscillator to produce an output in the absence of a reference. The 3250 also provides a color frame identification pulse.

CDL showed a new digital sync decoder which detects from reference input the correct mode of operation for optimum system performance: color lock, mono lock, free run and sub carrier lock.

A color encoder for IVC 90 and 15 cameras was shown by Lenco Electronics. The new encoder included a sync generator so that the camera could be remotely controlled.

In the automatic image enhancer category, CBS Labs announced a new "Mark IV" line of low noise types. The luminance signal is combed to improve the signal to noise ratio. (Color subcarrier is removed for the detail signal by phase cancellation before the detail is inserted in the main video.)

The Mincom Div. of 3M announced a contours-from-green Image Enhance to improve the final video. As another addition to its growing line of accessories, Mincom also came out with Video Source Identifier. The unit is an alpha numeric generator to solve video labelling problems. VSI-inserted characters travel with any composited video signal and appear on picture monitors to keep switching order clear.

Another product from CBS Labs was a new model chroma key, the 7010. The unit eliminates the need for an external keyer and no system retiming necessary since the delay is less than nanosec. The key is "quiet." The unit permits a signal to be sent over a network with a "blue flat" background so that a local scene can be inserted in each city.

continued on page



# Cohu's "Performer"

Our Model 1500 Broadcast Color Film Camera users tell us the 1500 is the best dollar-for-dollar telecine camera available. They like its performance, its stability, its reliability, the fact that it is virtually maintenance-free—and they like its price.

We know we have a good camera, we designed it that way. Features like Instant Paint to correct for poor film quality, an automatic sensitivity control that combines automatic light and automatic target control, RGB image enhancement that provides both horizontal and vertical aperture correction, gamma correction continuously variable from 0.5 to 1, 50dB minimum signal-to-noise ratio, geometric distortion less than 1%, and fully sealed optics are a few of the reasons why the 1500 is regarded as a standard in the industry.

Plus the 1500's flexibility to accept a wide range of image pickup tubes including the 8541A, 8507A, 8572A, 4809, and 4809B (a plumbicon version is also available); highly efficient optics permit operation of the vidicons at relatively low target voltages and low dark current levels which extends tube life; it's simple, fool-proof, easy-to-operate monitoring and switching system; and much more.

Dollar-for-dollar Cohu's 1500 telecine camera makes cents. But don't take our word for it, make us prove it. Contact your local Cohu Sales Engineer or Cohu, Inc., Electronics Division, P. O. Box 623, San Diego, Calif., 92112 or telephone (714) 277-6700. TWX 910-335-1244.

The one that still costs less  
and saves more.



You expect more from



and you get it.

Low England Bedford, Massachusetts 617-275-0370 • New Jersey Florham Park, New Jersey 201-377-6636 • Great Lakes Des Plaines, Illinois 312-824-4422 • North Central States Lincoln, Nebraska 402-467-2900 • Rocky Mountain Denver, Colorado 303-673-8835 • Texas Arlington 817-461-1707 • California Thousand Oaks 805-492-1896, Cerritos 213-926-7002, Palo Alto 415-326-0280

Circle 121 on Reader Service Card

## NAB SHOW-IN-PRINT

TeleMation showed a new digital sync generator, the TSG-525. In the form of a modular card, the SG mounts vertically in a 5¼ in. frame and can be intermixed with DA cards, etc. A whole new rack system for holding 5¼ in. cards in the vertical position was introduced by TeleMation. To go with the rack system were new pulse and video DAs, a 5x1 switcher and other accessories.

TeleMation also introduced at NAB 1974 a video processing amplifier, TVP-1000 to work with either helical or quad VTRs. Unit can effectively remove 25 V peak-to-peak common mode hum from the incoming video.

A new source of pulse and distribution amplifiers at NAB was Cooke Engineering which normally has shown only coaxial patch and switching equipment. Size is one unit high (1¾ in.); four will fit across in a rack.

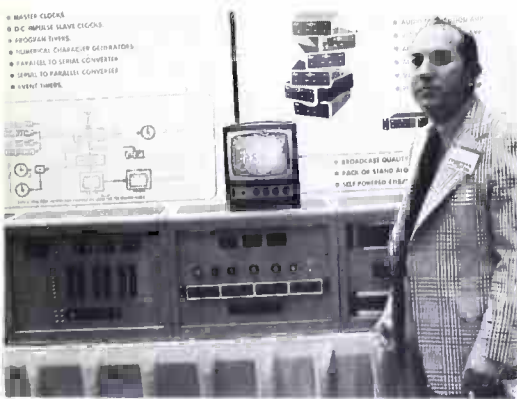

Cooke Engineering's program timer system.

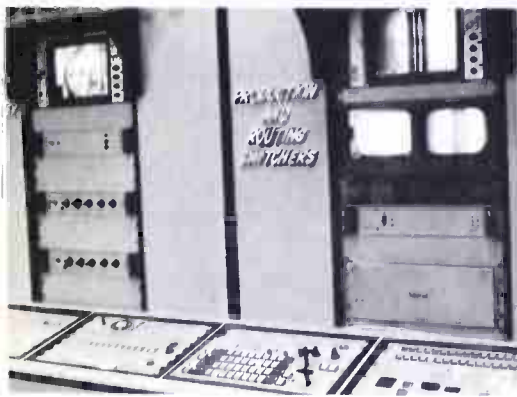

Telemei's production and routing switchers

New compact routing switcher from TeleMation.

Cooke also introduced a program timer system built around the digital clock driver, Model 712. Other units in the system include a numerical character generator to display real time on a CRT, event timer, slave clocks, and remote time readouts.

### Character gens: another flood gate open

At a number of booths at the show, visitors could be seen seated in front of keyboards, happily writing alphanumeric messages to themselves on monitor screens. The visitors were enjoying spins with the latest generation of character generators, and the abilities of these machines not only for writing the message on screen but for coloring it, flashing any part of it, rolling it, crawling it, expanding or contracting it, etc., etc., were fascinating enough to keep broadcasters pushing the buttons for extended tryouts.

Character generators reached new heights of resourcefulness and

flexibility, as set forth in detail in BM/E's article in the March issue. And CG makers are clearly being pushed strongly along by 1974's competitiveness. CBS had their well-known Vidifont system on demonstration. Chiron was welcoming visitors who wanted to try the Mark II and Mark III systems and Datavision offered a trial of the new D-3000 to all comers. TeleMation showed no less than three different CG's. Video Data had its low-cost systems on hand.

RCA, a source not on hand for BM/E's March survey, introduced its "Video Four," a high-resolution, high-flexibility system with floppy-disc memory and extensive display resourcefulness, including keyboard-generated font styles and graphics, using a built-in computer.

RCA's system, in fact, along with those of CBS and Chiron, made up the class of "most resourceful." Here were such capabilities as flashing any combination of letters or words, selectable multi-color, continuously adjustable character size, character insert, delete, and motion, adjustable "window" for rolls and crawls, and much more. Memory is in the 2000-3000-line range, with the floppy disc becoming something like a standard. CBS and Chiron, with their camera-scanned artwork, and RCA with its computer font origination, can create almost any graphical input, from any variety of font to symbols, even simple animation (RCA).

Somewhat below these three in fanciful capabilities, and substantially below them in price, but at the top in character resolution, floppy disc memory, and supplying all the most needed modes—crawl, roll, word flash etc.—was the Datavision 3000. Simpler and less expensive still, was the new TeleMation TCG-1432, designed primarily for use with weather time/news systems, but also with keyboard for remote and studio input of moderately-long messages. TeleMation also showed their older TED system which uses a computer for instant tally of election results, and the TCG-1425, a more elaborate system with a lot of the advanced capabilities.

At the lower end of the cost scale were video Data's wire-service unit the CG-100 Series, which can be expanded with options to include keyboard entry and other refinements.

We can guess that with the infinite resourcefulness at reasonable cost available in modern integrate-circuits

continued on page 43



Production and routing switcher from Richmond Hill.



# Require Accuracy?

(and peace of mind)



## then buy Belar

### Here's why:

■ Separate 100% negative modulation peak indicator lamp—detects the absence of carrier on program peaks for a true 100% negative indication.

■ Normal peak indicator lamp may be set to +125%—an accurate measurement to keep you within FCC modulation limits. ■ Built-in true modulation calibrator—means that you can check the modulation calibration at any time. ■ True peak reading modulation meter—switchable to read either positive or negative peaks, to accurately measure the short duration program peaks encountered in today's programming. ■ Expanded scale carrier level meter—allows the accurate measurement of carrier shift. ■ Extremely low distortion demodulator—permits accurate proofs at

100% modulation as well as accurate measurement of program peaks. ■ Built-in off-frequency alarm drivers—permits unattended measurement of frequency—alarm alerts you to any off-frequency condition. ■ Digital counter circuit—will measure any standard broadcast band frequency spaced 1kHz. ■ Built-in  $\pm 20$  Hz frequency calibrator—allows you to check the calibration of external equipment such as automatic loggers. ■ Built-in carrier-off alarm—tells you when the transmitter is off. ■ Off-air monitoring with the addition of the RFA-2 RF Amplifier—wide range AGC means hands-off operation at the studio. ■ 100  $\mu$ V sensitivity with RFA-2—handles the most difficult receiving problems with ease.

For further information call or write today.

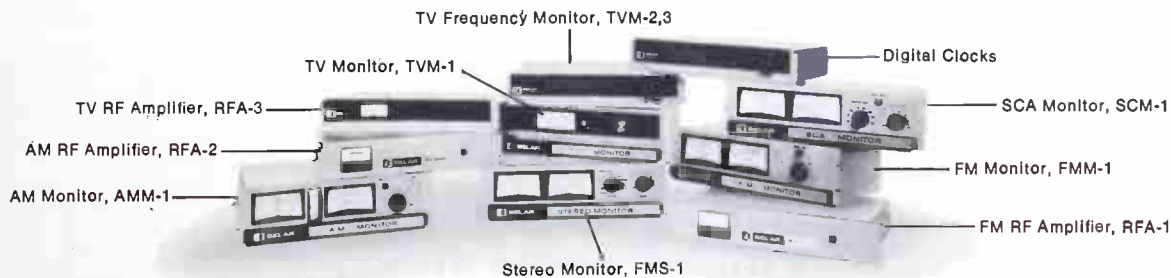

## BELAR

### ELECTRONICS LABORATORY, INC.

LANCASTER AVENUE AT DORSET, DEVON, PA. 19333 • BOX 826 • (215) 687-5550

Where Accuracy Counts . . . Count on Belar

Circle 122 on Reader Service Card

# VIDEO TAPE CONFIDENCE

**RECORTEC** equipment will relieve your VTR of all time consuming functions not related to revenue production.

## Video Tape Conditioner

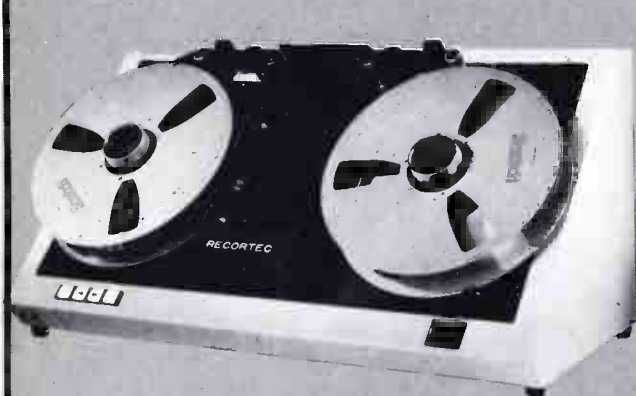

- Extends tape and head life by removing loose oxide and debris from tape surfaces.
- Improves quality of video recording due to reduced dropouts.
- Minimizes tape damage by improving the tape pack.
- Options such as erase, splice count, audio playback, etc., are also available.

## Video Tape Evaluator



- Display total number of edge damages.
- Display total number of surface defects.
- Display total tape time.
- Tape fully cleaned, uniformly packed and degaussed.
- Increases VTR utilization.

Plus additional capabilities

- Audio Playback
- Video Tape Addressing
- Video Tape Tailoring

# RECORTEC, INC.

777 Palomar Street  
Sunnyvale, California 94086  
(408) 735-8821

Circle 123 on Reader Service Card

# VIDEO TAPE CONFIDENCE

AND

# RECORTEC

GO HAND IN HAND WITH THESE CUSTOMERS

---

## Los Angeles

ABC-TV	KHJ-TV
AFRTS	KTLA
Ambassador College	KTTV
Apollo Film & Tape	KWHY
CBS-TV City	Metromedia
Consolidated Film	NBC-Burbank
EVAL Services	Trans-American Video
JPL	Video Tape Co.
KCET	Vidtronics

## New York

Advertel	Reeves Cinetel
American Pictronics	Tele-tape
Directors Studio	WABC-TV
EUE/Screen Gems	WCBS-TV
Grumman Data	WNBC-TV
Hughes TV Network	WNEW-TV
Many other installations throughout the United States	

---

## International Installations

Australia	West Germany	Japan	Portugal
Austria	Hong Kong, B.C.C.	Korea	Poland
Brazil	Hungary	Kuwait	Republic of China
Canada	Iceland	Malaysia	Switzerland
Chile	Iran	Mexico	Thailand
Denmark	Israel	Netherlands	United Kingdom
France	Italy	Norway	Yugoslavia
East Germany		Peru	

---

Join this knowledgeable group today.  
Include Recortec equipment in your videotape plans.

# RECORTEC, INC.

777 Palomar Avenue  
Sunnyvale, California 94086  
(408) 735-8821

Circle 124 on Reader Service Card

## NAB SHOW-IN-PRINT

technology, the end is not in sight for advances in character generator capability. It will come down to what the broadcaster wants to pay for. Right now, he can get far more than he ever imagined in the way of character generator operation at prices in the \$30K - \$50K range. And, the industry is offering a sensible set of options, with units available at moderate cost, in the \$1K - \$5K range, that will do very well everything many broadcasters and cable operators need; and a number of intermediates. If you want a computer, too, however, it will cost you more.



Chiron character generators.



Datavision's new character generator used disc memory.

RCA's approach to character generators used computer and floppy disc.



Character generators look highly useful to the broadcaster, good market-builders for the makers.

### Videotape editors: Simpler or more complex

One of the fast-growth technologies important to many broadcast operations is automated videotape editing, which started to explode about three years ago and has been pretty well keeping it up since. As noted in BM/E's January article comparing the positions of tape and film in broadcasting, automated videotape editing has become one of the big plus factors for tape, giving flexibility and ease to program editing that outdo those of film editing—and at lower cost. Videotape editing comes in a wide range of automation levels, from frame-sequencing semi-manual systems, at \$10,000 or less, up to highly automatic computer controlled systems at \$100,000-plus.

Continued advance was seen at the show in some new systems that moved in the direction of simplicity and lower cost. CMX, now owned by Orrox, unveiled the new CMX-50, a self-contained, stand-alone, computerized "off-line" system which uses standard 3/4" videocassettes as the editing medium. The price is in the under \$40,000-to-under \$75,000 range (depending on options), or roughly half that of the larger on-line system. The CMX-50 has most of the control features of the larger system such as automatic frame-accurate cuts, dissolves, wipes, keys, etc., plus edit decision preview, re-edit capability, and separate simultaneous editing of audio and video. In the case of the CMX-50, as with most off-line editing systems, after the "work-print" is finished, the machine can generate a punched-tape "decision list," which can then be fed to an on-line system for automatic assembly of the final quad master from the original quad materials.

The same general approach is put to use in the new Datatron 5350 system, which cuts the cost of the editing equipment to a low-end \$7000 by making the edit insertions manual, using thumb-wheels to set in SMPTE code numbers for the frame selections. Once a frame has been chosen for a cut or other edit decision, push-buttons carry out the decision. The system includes just three main units: a new SMPTE code generator and code reader, and the thumb-wheel selection unit. The system can interface with 1" helical machines, working with material dubbed from the original quad tapes, and



Central Dynamic's low-cost edit system, the EDS-200.



New CMX-50/editing system used Sony U-matic video cassettes.

like the CMX-50, generates a punched-tape decision list which can then be taken to a post-production house, along with the quad originals, for automated assembly of the edited quad master.

CMX was also showing its larger CMX-300 and CMX-400 systems; and Datatron had the Vidicue 5050, which has considerably more automation than the low-end system.

Central Dynamics was on hand with their well-known computerized PEC-102 newly adaptable to either on-line or off-line editing with its full array of editing capabilities, with very flexible interface potentials, at a price in the \$60-70,000. They also showed their low-priced EDS-200 Edit-Decision System, introduced earlier in the year. This under-\$15,000 system demonstrated off-line editing at the show with two IVC-870 helical machines connected. Dynasciences and Telemet demonstrated editing equipment shown at earlier conventions.

The message from Houston on videotape editing, in sum, echoed that from other sections of the show: more products, more flexibility, a wider price range that reaches down to match the very-small-station budget.

### Videotape—"breakthrough" announced

Videotape exhibitors can always get a big play at conventions simply by replaying "funny" or "sexy" TV programs. This year a few out-takes on

continued on page 48

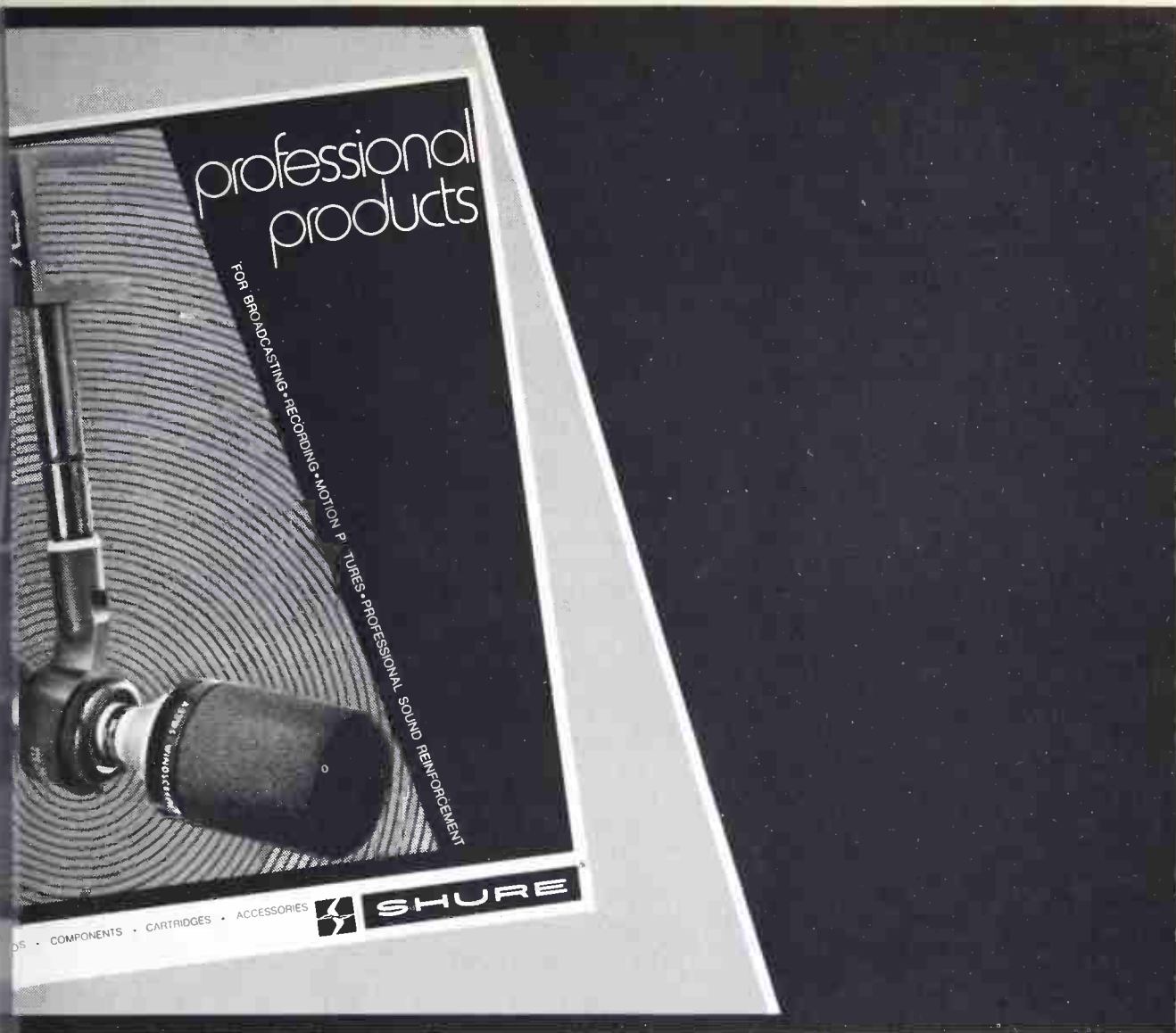

## Studio equipment home shopping guide

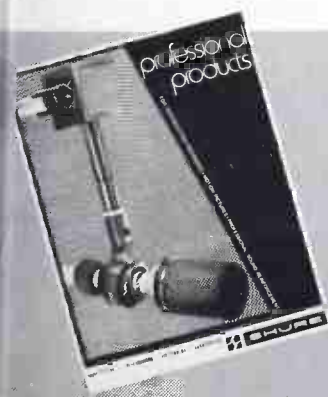

In the world of the professional sound engineer, advance follows advance, and new product follows new product. Bring yourself up-to-date with the *Shure Professional Products Catalog*, 24 pages of Shure products to make your job easier: the *SM61 Microphone*, beautiful to look at and virtually immune to noise in hand-held applications . . . the *SM7 Microphone*, with built-in, visually monitored, response tailoring . . . the ultra-versatile *SM53 Microphone*, with its own system of accessories . . . the *SE30 Gated Compressor/Mixer*, for "hands-free" gain riding . . . the *SC35C Phono Cartridge*, the first cartridge optimized in design especially for on-the-air playback . . . and the incomparable *V-15 Type III Phono Cartridge!* For your own copy of the catalog No. AL 312, write:

**Shure Brothers Inc.**  
 222 Hartrey Ave., Evanston, Ill. 60204  
 In Canada: A. C. Simmonds & Sons, Limited



Circle 126 on Reader Service Card

## NAB SHOW-IN-PRINT

streakers caught by enterprising station newsmen, helped draw crowds and noise, drop-outs and poor color were frequently overlooked.

Memorex, however, coming out with a Master Grade II videotape which specified AMRF and microdropouts, went to special efforts to draw close inspection to its product. It relied on an expert pantomimer to challenge viewers to tell live camera from tape playback. 3M, less dramatically, but nevertheless calling it a breakthrough in video noise reduction, introduced MT2250, a new formulation at the show. (2 to 4 dB less noise and better at low frequencies.) Ampex had a new tape 176 designed to provide good audio at 7½ ips on its new AVR-2 machine. Fuji stressed the properties of highband videotape H701.

For those seeking tape bargains, The Video Tape Company was on hand selling reprocessed tape, such as Chroma 90 and Scotch 400 at low prices.

### Film: news gatherer, program source

"Electronic journalism" was very big at the show, as noted in the forego-

ing, but film is still the major news gatherer for television. Two camera makers who sell a lot of 16mm cameras to television, Cinema Products and Paillard (Bolex), came to the show.

Cinema Products had an important innovation—a *reflex* 16mm series designed specifically for television news gathering and documentary production, the CP-16R and CP-16R/A. The mirror shutter is set at a 45-degree angle, and rotates at half speed. It stops automatically in a viewing position. The standard reflex viewfinder is fixed, about 1" back of the film plane. It can be replaced by an "orientable" erect image view finder. The cameras also have sync (crystal controlled) and variable speeds, up to 36 fps, and automatic and semi-automatic exposure control.

Paillard showed the familiar, extensive line of Bolex 16mm cameras, stands and accessories.

Eastman Kodak put strong emphasis on their new Super 8mm equipment. Central broadcaster interest probably was on the Supermatic 200 single-system super 8 sound camera, which is enjoying considerable popularity as an extremely light-weight and inexpensive news gatherer for television. Also on view were the Supermatic 8 color



Memorex stressed uniform quality playback undistinguishable from live camera.

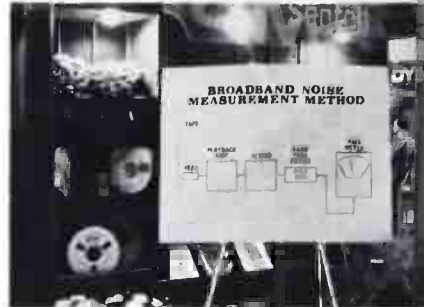

3-M announced a new low noise tape, MT2250.

processors, the Supermatic 70 sound projector, and the VP-1 film video layer, all products introduced in the last year or so.

There was also plenty of equipment continued on page 105

Split-level Albert Thomas Convention Center at Houston gave everybody more room.





**You can see it, you  
can hear it, and  
you get it in every  
piece of equipment  
we build.**

**Quality, performance  
and reliability.**

Collins traditionally has been in a class by itself as a supplier of high quality, high performance, high reliability broadcast equipment.

You probably know that.

But if you think you can't afford Collins equipment, here's something else you should know: Collins is competitively priced. We'll match our prices with competition anytime. On transmitters. On consoles. On antenna systems. On programming equipment. On any equipment you use.

And we haven't sacrificed anything in the way of quality, performance or reliability. We back everything we make with a two-year warranty. Plus 24-hour, on-call service — which

means you get help if you need it.

AM. FM. Stereo. Broadcast equipment from Collins. Competitively priced to give you the best sound on the air.

For a copy of our new Broadcast Equipment Catalog No. 47, write to us on your company letterhead. Collins Radio Company, Broadcast Division, Dallas, Texas 75207.  
Phone: (214) 235-9511.

**Collins Broadcast Equipment**



Circle 119 on Reader Service Card



Cinema Products camera in action.



Eastman Kodak's high speed Supermatic processor.



Instant Caption slide projector at Listec booth.

for utilizing film programs as video programs. TeleMation brought production models of their TCF-3000 color film camera, shown in prototype last year. The camera has prism optical input arm adjustable for entry on left or right (four positions), internal diplexer, automatic black, automatic white, 60 vector color corrector.

Cohu showed their new Model 1500 color film camera which also has many advanced features: geometric distortion is rated less than 1%, s/n ratio is 50 dB minimum; camera has breech-loading yokes, modular electronics on epoxy printed circuit boards, instant pairing control for offsetting poor color in the films used. Cohu also showed their companion optical multiplexer, the new model M-3, which can form the basis for a telecine system using many different types of film equipment.

The telecine shelf at the show was full: there were familiar systems from RCA, Gates, Philips, Marconi.

Film processors were shown by Jamieson, and Technology Inc.

**Radio automation: choose your way**

For some time radio automation makers have been developing products... continued on page 5

# Spindler & Sauppé TV film chain 2x2 projectors

your widest  
*and wisest choice*

Seven models in all — one of which will fit your needs *exactly*. Color or monochrome; uniplex or multiplex; forward or reverse actuation; sequential or random access; 16- to 96-slide capacity. These are thoroughly proved performers, built to the highest professional standards, and recently updated with advanced electronics.

For complete information, write **Spindler & Sauppé**, 13034 Saticoy St., North Hollywood, Calif. 91605; phone (213) 764-1800.



**SPECTRUM 32B:** The most advanced film chain slide projector available. For color or monochrome chains; 32-slide capacity. Many exclusives. Operates at 120V, 50/60 Hz. Spectrum 32F operates at 220V, 50/60 Hz.



**MODEL 332:** Newest version of the work-horse of the industry. For monochrome chains; 32-slide capacity. Model 322: single turret for 16 slides, monochrome or color.



**MODEL SLX-TV:** 96-slide capacity, random access. Model SLS-TV: 48-slide, random access. Model SLD-TV: 96-slide, sequential. Model SLR-TV: 48-slide, sequential forward/reverse. All for monochrome or color chains.

Circle 129 on Reader Service Card

Circle 130 on Reader Service Card

# PEC-102

## Complete System Approach Computer Controlled VTR Editing... by Central Dynamics

A frame-accurate editor for creative people, designed for your present and future requirements . . . with outstanding features including:

- Mimic CRT diagrams for Off-Line and On-Line edit modes graphically display current status of all operations including data entry, scene location, edit rehearsals, and automatic assembly.
- A control panel designed for the editor.
- Instant "call up" and control of all computer programs.
- Edits on any frame . . . with accurate color framing.
- Continuous SMPTE Time Code recovery and display for faster and more reliable editing.
- Audio edits can be offset from video and executed in the same pass.
- Edit-on-the-Fly.
- Performs open ended edits.
- System stores up to 600 edit scenes. Any edit scene can be called up, displayed, rehearsed, and changed at any time.
- Automatic control of audio/video switcher with full Mix/Effects capability.

- Interfaces to Quad, helical, multi-track audio machines and SLO MO's.
- Hardcopy output of edit decisions printed on demand.

The PEC-102 is an example of our "Total Design and Manufacturing Approach" to video tape editing systems . . . Hardware, Software and Service . . . all by Central Dynamics.

If you need more convincing, send for our PEC-102 and editing equipment brochures, or ask to see the PEC-102 in action. They are operating in most major cities across the country.



**CENTRAL DYNAMICS LTD**

**Canada:**

147 Hymus Blvd., Montréal, Que., H9R-1G1  
514-697-0811

**U.S.A.**

230 Livingston Street, Northvale, N.J. 07647  
201-767-1300

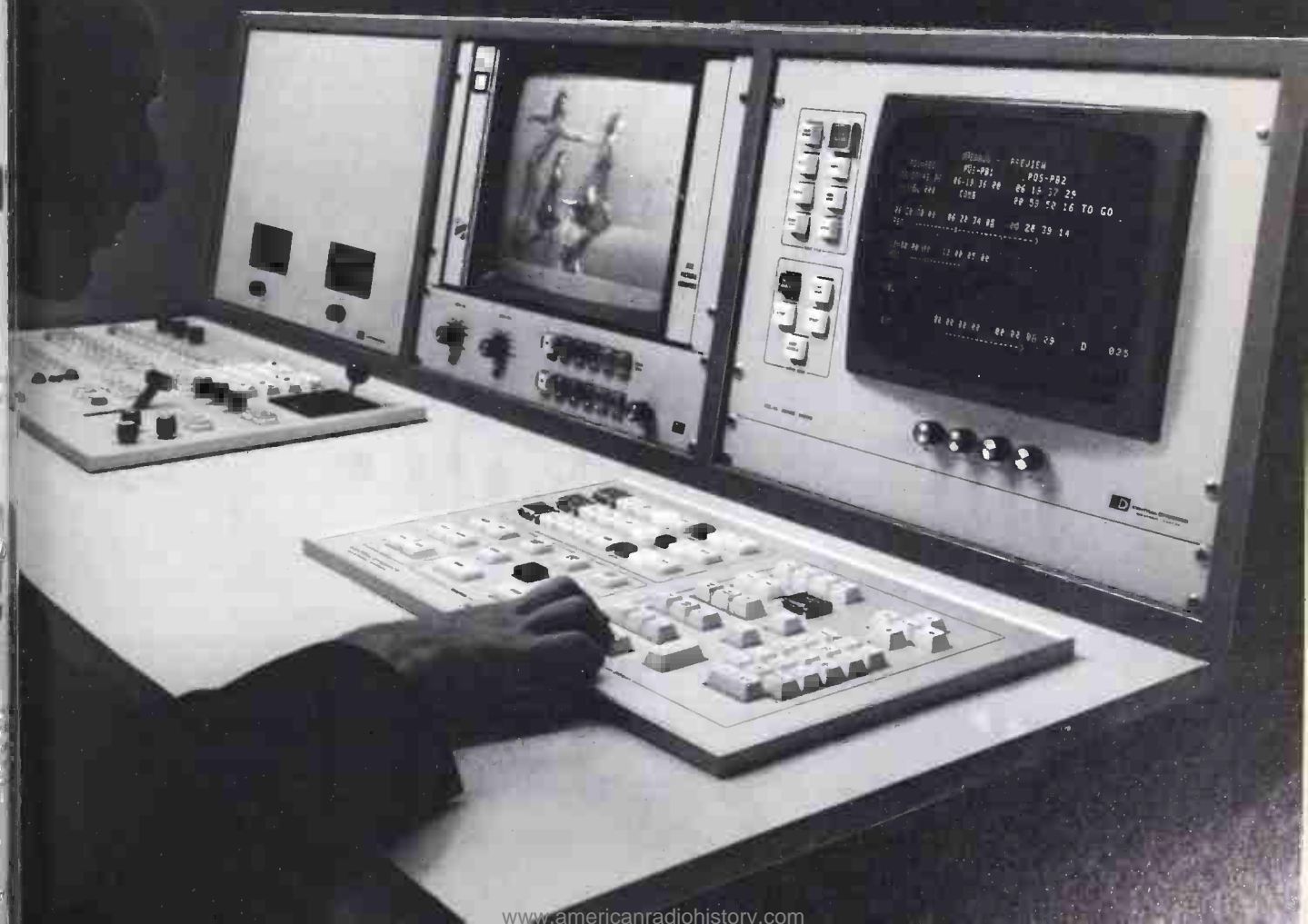

## NAB SHOW-IN-PRINT

to gainsay the early reputation of automation as a do-everything genie, always demanding massive capital investment, far beyond the small station's reach. The Houston exhibits extended and sharpened the movement toward simplicity and low cost. But alongside that movement was a strong one toward *more* automation, more flexibility, larger capacity for unattended operation.

In the simplicity direction were such devices as the Ward-Beck audio console with 10-step pre-settable switching; the Gates RA-10/SS-10 system, another ten-event switcher; the Broadcast Electronics simple cart-sequencing system, using the 150-Hz sensor tones, available with any number of carts from three up; the Schafer Formatter.

At an intermediate level was the Broadcast Electronics plan for using a cart to supply memory for extended program direction, a way of getting pretty long operation without the cost of a computer-type memory.

Going toward more flexibility and automation were the Schafer 7-day

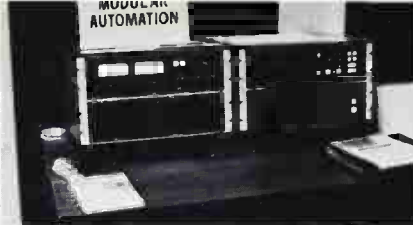

Control Design's new automation controller.



Control Design's cartridge player is removeable.



Schafer showed system with new cart player.



Autogram showed low cost automation.



Close-up of Schafer cart player for automation.

## PERFECT YOUR CCTV SYSTEM WITH COSMICAR<sup>®</sup> LENSES

A rich variety of COSMICAR CCTV lenses will ensure you to satisfy any of your technical purpose.



Be sure to get the finest image recording results with quality Cosmicar lenses.

Also available are scores of other lenses, ranging from 4.8mm to 1,000mm telephoto, zoom and the motordriven among them, for immediate delivery after being tailored to your specifications.



**COSMICAR OPTICAL CO., LTD.**

424, Higashi-Oizumi, Nerima-ku, Tokyo, Japan

Cable Address: "MOVIEKINO TOKYO"

Representative & Service Office: Asahi Optical (America) Inc. 15 East 26th Street, New York, N.Y. 10010, U.S.A.

Circle 131 on Reader Service Card

memory for the 903 system; their new 48-cart playback system, the Audiofile, which holds the carts still in three stacks and moves the three playback units vertically; and their Autocue, which automatically rewinds and re-cues open-reel programs that are to be played repetitively.

Schafer also made the important announcement of an agreement to market a line of computer-controlled automation equipment, made by Northwest Technology, Inc. The line is the 700 Series formerly sold by International Good Music. That brand name, so prominent in radio automation in recent years, is temporarily off the market during a "major financial surgery" involving a voluntary liquidation of what will now be called the "old IGM," and the transfer of assets to Northwest Technology, Inc. The latter firm will create the "new IGM," with substantially new ownership, later this year. The IGM 400 and 500 series, and the Instacart, will be among the products the new company will market.

Meanwhile, as reported elsewhere here, the BAT data-processing systems of IGM are now sold by a new company, Paperwork Systems, Inc., which showed them at Houston.

Coming back to Schafer, it is clear that adding the IGM computerized series to their established 900 line will give them an impressive range of automation equipment.

Also very much in the more-flexibility direction was the new CD28 controller introduced by a new source, Control Design Corp. (CDC includes some key personnel from the now defunct Broadcast Products Co.). The CD28 can program up to 2000 events from 12 audio sources (expandable with options to 8000 events, 92 sources). It uses keyboard entry of digital program identification, location, and function data. Control Design also showed a new carousel-type cart player with what looks like a very useful innovation: the whole drum, with carts enclosed, slides off the machine, to be stacked for a new form of program storage, while another pre-loaded drum is slipped on. CDC also claimed improved stereo phase control and reduced search time for the new unit, called the CD24R.

RCA introduced the DAP-5000A, an upgraded version of the DAP-5000 available earlier, another digitally-controlled, keyboard-entry system with 2000-event 12-source capability (expandable with options). It has numerous flexibilities that give the station

continued on page 54

# Video Engineers, do you want to *delay* pulses

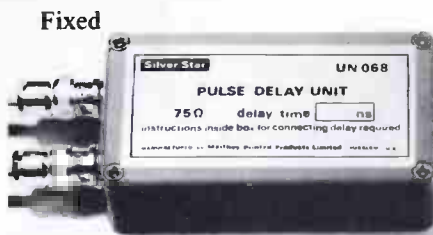

Fixed

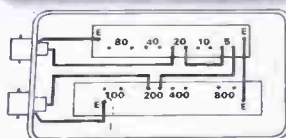

Example for wiring 225ns Delay Lines shown looking into pins

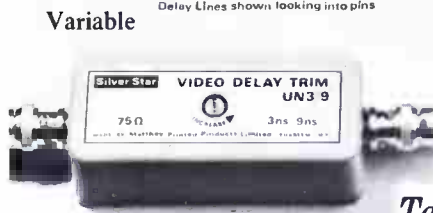

Variable

## Pulse delay unit UN068

1. Open it
2. Connect your delay time 5ns to 4500ns (Wiring diagram inside)
3. Close it
4. Plug into Cable

Max rise time 280ns suitable for Studio timing

## ... or trim Video

### Video delay trim UN3/9

1. Plug in
2. Adjust fine trim Range 3ns to 9ns (2ft to 6ft coax).

Also used for Video Timing

*Television Equipment Associates*

BOX 1391 • BAYVILLE, N. Y. 11709

**Matthey** Pulse Delay Units

phone (516) 628-8068

Bill Pegler



Circle 132 on Reader Service Card

## Optima Racks: solid and good looking.

High performance design and construction with a purpose—to enhance your product's function and appearance. 52 sizes and plenty of options for 19 and 24 inch instruments. Choose from hundreds of two-color combinations of a durable

vinyl finish. Get information on the complete Optima line of cases, consoles and racks. Write Optima Enclosures, Division of Scientific-Atlanta, Inc., 2166 Mountain Industrial Boulevard, Tucker, Georgia 30084. Or call (404) 939-6340.



Circle 133 on Reader Service Card

## NAB SHOW-IN-PRINT

operator miles of scope, such as instant re-sequencing of program sub-blocks in any memory position. Memory is solid-state MOS, using all-digital logic. The program is similar in a number of ways to that of Control Design Corp.'s CD28 system (above).

Systems Marketing Corp. (the Carousel makers), had an advance model of a new computer-controlled automation system, to be available with either MOS or ferrite memory, with storage expandable from 1000 events to an almost unlimited top. It would be run by a micro-computer. SMC personnel indicated that the advance model was intended to get some potential user reaction, because the final design can go in several directions: they hope to market the system on a more or less "custom built" basis, responsive to each buyer's wants. SMC also had new reel-to-reel availability on their complete systems, using Studer transports with SMC modular electronics.

Autogram, a Texas automation



New Grass Valley unit "instructs" auto-switcher that machine is loaded.



Central Dynamics' new APC610/200 (above) automates both traffic and switching; APC610/100 (below) handles technical operations only.



## Greater Computerization of TV Operations Forecast

Increased use of computers for a wide range of broadcast operations was the prediction of a panel of automation specialists and users at the 1974 NAB Convention.

The six technical experts described for a joint meeting of TV managers and engineers, ways and means in which computerization will grow in such diverse areas as engineering, operations, testing, billing and accounting.

Panelists were George Beattie, Kaman Sciences/Broadcast Computer Services; Adrian B. Ettliger, Grass Valley Group; Ray Johnson, KMED-TV; Charles Magee, Westinghouse Broadcasting; Howard Shephard, Central Dynamics Corp.; and James Ziegler, Data Communications Corp. William B. Honeycutt, KDFW-TV, moderated.

Honeycutt observed that some computers today provide either billing or technical services for TV stations but that a marriage of the two systems is not here yet. The panel responded that uses for computers will grow beyond the current concentration on traffic function, such as billing. From an engineering standpoint, Ettliger said that totally integrated computerization is "definitely in the future" as hardware cost comes down, thanks especially to mini-computers and mass storage capabilities.

Beattie, whose firm has been involved in offering computerized business services to broadcasters, said companies such as his will be able to interface with whatever sorts of equipment broadcasters want to use.

Ziegler forecast that computerization will move quickly into such areas as engineering operation and inventory control. He noted that the industry is on the first fringes of computerization which involves connections between station and advertising agencies in lining up commercials.

Ettliger made the point that the major barrier to computerization is "the people problem." One of the problems is the cross-disciplinary language barriers when broadcasters and computer experts try to resolve the needs of the industry and how to meet them.

Johnson predicted that almost every broadcaster will eventually go into some form of computerization—if only to handle the increasingly complex billing and accounting demands of the industry. To that, Ziegler pointed out that far less than one-fifth of the nation's TV stations are now using computer services, so there is much room for expansion.

Magee, whose Group W stations are involved in computerization projects, characterized his company's work as an optimization of functions. "We believe the system's potential has not been fully developed and Group W is trying to find new ways to use the computer," he said. He cited programming of videotape cartridges as a prime candidate for computerization.

Shepard termed computerization as a major work load leveler, which would permit station personnel to even out the demands made on them. Like the other panelists, he said that computers would allow for a reduction of staff in rote jobs or jobs which are prone to errors. Ziegler predicted that the advent of videotape cartridges will make it possible to have programs which are put together almost totally without human hands.

maker aiming with considerable success at the small and medium-station market, showed their carousel-equipped systems. Gates showed their complete carousel-equipped systems, which are available with reel-to-reel machines the customer wants, from Revox A77 to Scully LJ-10. CCA had on display their established line of automation systems using both carousel and open-reel sources.

In sum, radio automation, fitted closely to each station's needs and budget, which has been on the increase for several years, took a real leap forward at the show. Whoever you are, automation (or "partial" automation) now has something for you.

### TV automation—no stampede

Looking at TV automation from a switching point of view, the 1974 convention bore witness that the mil-

lenium, while getting closer, was not a hand. This was clear from the Engineering Session panel on automation as well as on the exhibit floor. The hardware core suppliers were on hand but they were down to four in number: Central Dynamics, Grass Valley, Sarkes Tan- zian, and Vital.

Of these, Central Dynamics put on the most impressive automation show. CD exhibited two systems: the total station automation system, the APC-610/200 which handles both traffic and technical operations and the APC-610.100 designed primarily for controlling technical operations only.

To clearly show what automation does, CD had a model operating TV station in miniature. When the CRT display said VTR No. 3 was on the air, you saw the model operating. Much of the 200 system demonstration showed

continued on page 5



# **COVER THAT SPECIAL EVENT!**

*with Portability Plus*

Some of our customers are covering important city council meetings, election returns, special sports events and other local origination features with the portable version of our compact Model 1501 AM microwave system. In other areas, this system is being used for standby emergency restoration service.

The simplex system shown here weighs only 31 lbs. and the accompanying control console only 40 lbs. The entire system can usually be set up and on the air in less than 30 minutes. The tripod can be extended to clear a six foot guard fence for clear line-of-sight shots. With a 2-foot antenna, the system has a range of about 6 miles.

This is the identical Soladyne microwave equipment that is serving MSO's across the country in permanent installations. For more information, call Fielding Hedges, at (714) 279-7872.



## **SOLADYNE**

**INTERNATIONAL, INC.**

A subsidiary of Rohr Industries

**7455 Convoy Court, San Diego, California 92111**

Circle 134 on Reader Service Card

## NAB SHOW-IN-PRINT

how traffic and program schedule building is being handled on line. Examples were typical of what is being done now at KYW-TV in Philadelphia. Visitors were also given an outstanding brochure on TV automation entitled "Help Wanted." The new 100 system displays scheduled program events; automatically operates the A/V switcher; and automatically pre-rolls and controls various machines. It also automatically calculates Schedule Time Ascendency checks. System includes a computer, CRT/Keyboard terminal, switcher and printer.

Grass Valley devoted a major section of its exhibit to a switcher controlled by stored events and showed a new machine terminal which could be set to instruct the switching computer that it (the machine) was loaded with the proper program material and ready to roll. System was part of that going to Australia.

Sarkes-Tarzian and Vital also had their production switcher demonstrations set up to show how stored pre-events can make complicated switches automatically.

### Business automation systems strong

Ideally, and some day soon, business automation systems and technical automation systems will interface perfectly and the versatility of a computer will be exploited in full (predictions from the panel discussion on automation, Engineering Session). In the

meantime, there are, for the most part, two sets of vendors: those selling hardware for automatic switching (with software thrown in) and those selling software for traffic/business applications (with hardware thrown in).

Business automation systems are going strong and as in other areas competition has created a service to fit almost any station's needs—small radio, large radio, small TV, and large TV.

A new corporate entity this year was Paperwork Systems Inc. PSI is the successor to IGM at least as far as the BAT systems introduced last year at NAB are concerned. PSI showed four systems: BAT 1000 (for single stations), BAT 1250 for single or multiple radio stations, BAT 1500 for busy radio stations and BAT 2000 for TV and major market radio.

Compu/Net was on hand and offered its services in five modules ranging from traffic to research. All put together, the company called it Radio II and stressed on-line computers and transactional system (which is a faster process than the traditional conversational mode as a means of getting information from the computer).

Datarad was the name of an on-line system for radio broadcasters offered by Automated Broadcast Services Inc.

BCS (Kaman Sciences) offering a service to both radio and TV stations continued to stress the in-station mini-computer but said its services also offered a central computer. BIAS, one of the other old-timers on hand, offered a new fast system.

Sarkes Tarzian talked Star-com as a sales managers tool, and also showed



Data Communications Corp. demonstrates new "fast" BIAS traffic automation.



Compu-Net had a new "transactional" traffic automation system.

how Star-com could be integrated with APT technical control systems to provide totally integrated TV automation. (In the fully integrated system category was also the Central Dynamics system described in the preceding section.)

### Transmitters: more choice, steady on design

The sharper competition in transmitters came from old makers filling new (for them) power slots, and one new company: Sintronics Corp., of Bryn Mawr, Penn.

McMartin moved into the one kilowatt radio field with a compact unit styled to be acceptable for a front office location. BA-1K is all solid-state except for the four 4-500A tubes in the modulator and power amplifier stage with pushbutton selectable 500- and 250-watt operation. American Electronics Laboratories showed their new 5 Kw AM-5KD and 10 Kw AM-10KD very similar in design except for the use of two 4CX3000A's for power amplification in the 10KD, one such tube for the 5KD. Both these companies took pride in the accessibility of all parts.

Gates stirred the radio design waters somewhat with their new MW-5, 5-kw AM unit using their patented pulse duration modulation, with claimed overall efficiency greater than 52%. The transmitter is all solid state—including the power rectifiers—except for the 4CX3000 modulator and 3CX2500F3 power amplifier. Gates also showed their F

continued on page

## Selected Highlights from NAB '74 Engineering Sessions

- A low-height (50-100 ft.) Perimeter Current Antenna for use near airports, hurricane-prone locations, etc. was described by Homer A. Ray of Continental Electronics Mfg. Co. Vertically-polarized ground waves are principal means of radiation.
- Accurate measurement of true values of instantaneous peaks of modulation (positive and negative) is now possible with digital peak modulation indicators, said Kenneth Frank of McMartin Industries. Engineers can now record true peak values and correct carrier shift problems.
- Fluorescent lighting for cycloramas provides more even distribution of light (less chance for hot spots or black holes) and permits savings of 60% in lighting power and 25% in air conditioning. Fluorescents also are efficient in producing red, green, or blue light, said Dr. William Glenn of CBS Labs.
- In reviewing transmitter advances in the last ten years, Brian Cox of Gates said new transmitters "will handle square waves . . ." Improvements include low distortion, excellent frequency response, high positive peak capacity, low or no carrier shift, increased reliability and a cleaner and louder signal.
- Monaural listeners of stereo broadcasts don't need to be cheated, said Ronald Eigenmann of Visual Electronics. Correction of stereo mono-sum error is possible by isolating and quantifying phase shift caused by reactance and then adjusting it out after comparing this with the phase "common-mode" program material.



# A smart FM station could get rich with a stereo playback monitor like this.

What you see here is an illustration of the relationship between reproduced QS-encoded 4-channel signals and their 2-channel reproduced signals.

A diagram that should make sound economic sense to any FM station owner or broadcasting engineer.

What it indicates, of course, is that when QS-encoded 4-channel sources are played back on your listener's 2-channel stereo

equipment, they are not only perfectly compatible but even provide a broader stereo perspective and sense of spaciousness.

We can put this another satisfying way:

By installing the new Sansui QSE-5B 4-channel encoder in any MPX-capable FM operation, you can broadcast exciting 4-channel realism while retaining all current standards of hi-fi FM stereo. Signal level, S/N, dynamic range, frequency response—are all handled and controlled like conventional 2-channel material.

And if these broadcasts happen to be reproduced at home in conventional 2-channel stereo, they will actually sound better than ordinary 2-channel broadcasts.

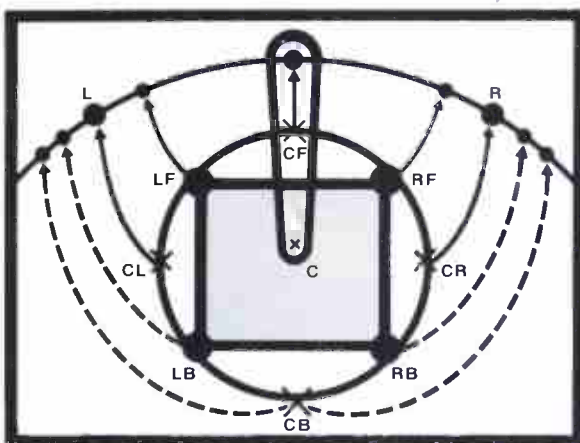

Obviously, it is hard to go wrong with a system like this.

Especially since an investment of about US\$900 buys and installs the QSE-5B and lets you reach the growing number of people who already own QS-capable 4-channel equipment. Especially those who own QS vario-matrix decoders that decode your 4-channel broadcasts with astonishing inter-channel separation. Or, indeed, those who own any FM

MPX-equipped stereo equipment.

The QSE-5B encodes discrete 4-channel tapes, demodulated Quadradiscs (CD-4) or any of your own live 4-channel material—even your very own 4-channel commercial spots—into two channels that you can then put on FM MPX waves.

Your listening audience enjoys stunning 4-channel realism. Or an improved 2-channel stereo perspective.

We feel they're going to appreciate you for that. Ditto, your advertisers.



QS 4-Channel Stereo. **QS** Are you listening?  
QS™ Sansui

ANSUI ELECTRIC CO., LTD. 14-1, 2-Chome, Izumi, Suginami-ku, Tokyo 168 Japan /Telephone: 323-1111 SANSUI ELECTRONICS CORPORATION  
NEW YORK: 55-11 Queens Blvd., Woodside, New York 11377, U.S.A./Telephone: 212-779-5300 LOS ANGELES: 333 W. Alondra Blvd., Gardena, Calif.  
9247/Telephone: 213-532-7670 SANSUI AUDIO EUROPE S.A. ANTWERP: Diacem Building, Vestingstraat 53-55, 2000 Antwerp, Belgium/Tele-  
phone: 3-315663-5 LONDON: 39-41 Maple Street, London, W1P, 5FU, England/Telephone: 580-5353-FRANKFURT: Reuterweg 93, 6 Frankfurt/Main,  
West Germany/Telephone: 590-700

Circle 135 on Reader Service Card

## NAB SHOW-IN-PRINT

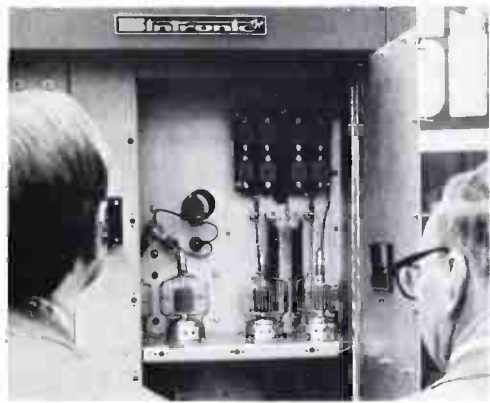

Sintronic, transmitter newcomer, had a 5 kw AM, other AM and FM.



McMartin's new 1 kw AM was designed to blend with office decoration.



New from Gates was a 5 kw AM using pulse duration modulation.



Wilkinson showed the AM-1000-B, 1 kw AM transmitter.

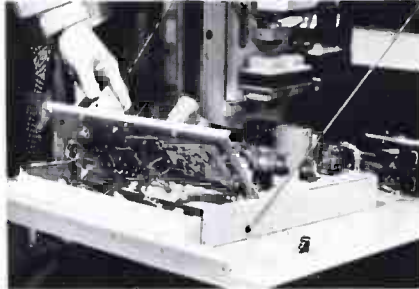

Inside the McMartin 1 kw AM.



Collins emphasized a new 40 kw FM transmitter with dual exciters.



New 10 kw AM transmitter was introduced by American Electronic Labs.



CCA Electronics had a full FM line, from 1 kw up to top power.

line, topped by the FM-40H3, a 40-kw unit.

Sintronic's maiden entry consisted of the AM-1K-A, a 1 kw AM model; the AM-5K-A, a 5-kw AM model; and the 10-kw AM-10K-A. Also announced were a 50 kw AM, and a line of FM transmitters, including models from 10 watts to 25 kilowatts.

Sparta brought something of a novelty calling it a "world's first": a 250-watt FM transmitter that can run entirely on batteries. Normally, the "experimental" Model 600BX runs on standard 115-volt ac power, but in any emergency it can go for two hours or more on a heavy-duty 12-volt auto battery. Sparta believes, according to the billing on this transmitter, that the threat of power shortages and the increasing responsibility of broadcasting in emergencies will give such a transmitter more and more relevance in the future.

Other makers with lines of radio transmitters at the show, were Wilkinson, RCA, Collins Continental and CCA. Collins had new 10 kw and 40 kw FM transmitters.

In television transmitters there were Gates, RCA, CCA. Gates introduced a new 60-kw UHF model, the BT-60U, using the intermediate-frequency modulation. The unit has dual 30-kw visual power amplifiers, which normally operate in parallel, but are automatically switched if one amplifier fails, so that power drops to 25% of the rated level. Manual switching can then by-pass the failed unit to raise output to 50% of the rating.

CCA had an updated version of their VHF television transmitters. LPB, at the low end of the radio price scale, introduced a new 10-watt FM transmitter for \$1,095, and a new 50 watt AM for \$1,495.

Introduced by Dynair was a new audio-video exciter for low-power broadcast, 2500-MHz or CATV applications. Dynair says the unit is on a par with IF-modulated exciters in performance. It includes an eight-section helical filter to provide good adjacent channel rejection.

In the low-cost range, Dynair introduced a \$495 modulator for MATV and CCTV use. The solid-state device claims excellent stability and takes up only 1¾ inches of rack space. A built-in bandpass filter allows adjacent channel operation.

New digital remote control system for transmitters came from McBee Laboratories, Moseley Associates, and Marti. The McBee Model D-144 system uses C-MOS integrated circuitry, LED display, autorange digital voltmeter. Moseley's new Model DRS-1 digital remote system has a 10-channel

continued on page 10

# The mike for all reasons.

If you ever wanted one microphone that could record anything and still meet tough professional standards, you want the AKG C-451. It's the only modular condenser microphone system in the audio world. You buy exactly the specialized components you need, without investing in microphone parts that aren't really necessary.

The C-451 offers you a range of six interchangeable capsules that twist-mount directly on the basic preamplifier module. This lets you meet the demands of just about any recording situation using only components from your C-451 System. In the hectic moments between sessions you can customize your set-up to give the in-coming Mozart string quartet the same quality attention you gave the outgoing rock superstar.

There are C-451 cardioid, rising-response cardioid, shock mount wind screen cardioid, omni-directional,

shotgun and short shotgun condenser components. All work with phantom powering, AC, or battery power supply. And there are currently 27 back-up components for unlimited versatility and convenience.

Add extra preamplifiers and you further extend your system's capability to cover any session, concert, recording or broadcast you engineer. You get the most value for your equipment dollars, plus the quality and dependability of an AKG condenser microphone.

The AKG C-451 System is available from your professional equipment dealer. Or write for your nearest dealer and details about the C-451 System.

**The AKG C-451 System**

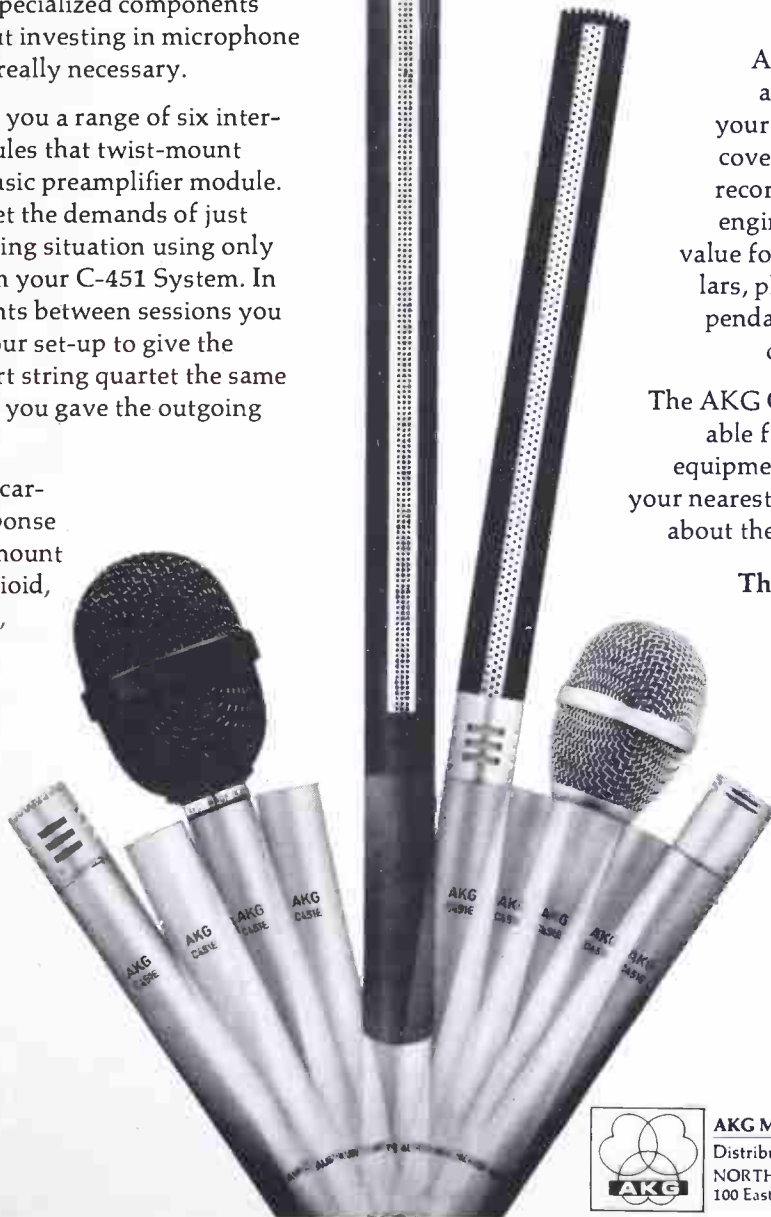

**AKG MICROPHONES • HEADPHONES**

Distributed by  
NORTH AMERICAN PHILIPS CORPORATION  
100 East 42nd Street, New York, N. Y. 10017

Circle 136 on Reader Service Card

## NAB SHOW-IN-PRINT

standard, is expandable to 20 or 30 channels. It has status panels with light indicators for both the control and remote positions. Automatic logging can

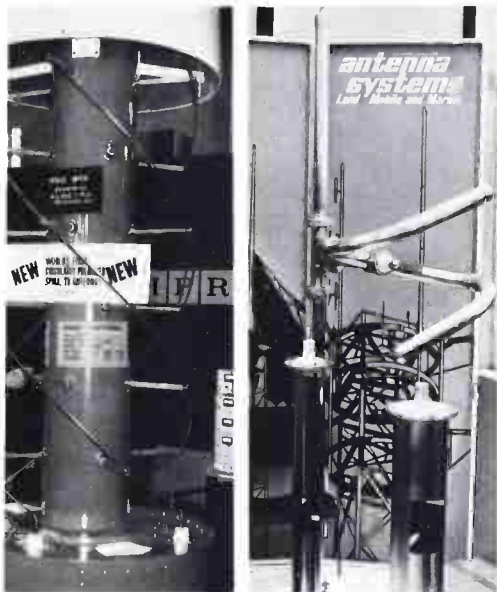

Among antenna makers, Jampro (left) showed new circular-polarized TV model; Phelps-Dodgen (right) had line of AM, FM, land mobile units.

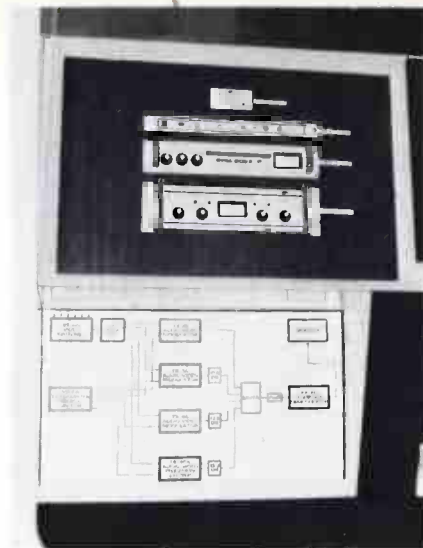

Dynair introduced new TV modulator and exciter units.

be added. Marti's system operates via a 950 MHz carrier for remote control and telemetering of radio transmitters.

An important development was the circularly polarized TV antenna introduced by Jampro, the only such antenna on the market at show time. It promises to provide improved signal/noise, and less ghosting, in its coverage area. The antenna is cut for any one channel in the VHF or UHF



Moseley had a new digital remote control system for transmitters.

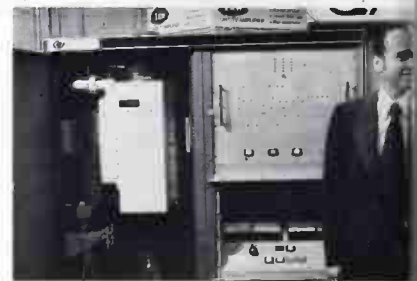

Acrodyne showed a 1 Kw UHF translator top of complete line.

range, and is rated for azimuth circularity within 2 dB. It is offered for input powers up to 50 kw on channels 2- and 100 kw on channels 7-13.

A series of new FM antennas came from Phelps Dodge, and an extensive line of AM, FM and TV antennas were shown by CCA, Jampro, Gates and RCA. Alford Manufacturing Company, Shively and Emcee were on hand to talk. continued on page

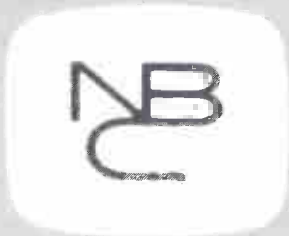

At NBC...



and CBS...



and ABC...



they use more BIW TV broadcast cable



... than any other brand.

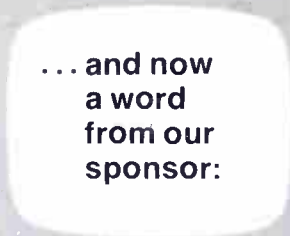

... and now a word from our sponsor:

The major networks prefer BIW TV cable for the same reasons local stations do. For one thing, they get proven reliability. BIW was the first TV cable manufacturer, has more experience than anybody else. We're now the supplier of cable for all TV cameras, plus accessory equipment for other studio cable and connector requirements. We also have both East and West Coast facilities for on-the-spot supply, service, and technical help. Write for literature. Or call.

Thanks for tuning in!

**Boston Insulated Wire & Cable Company**

65 Bay Street, Boston, Mass. 02125  
Court Street, Plymouth, Mass. 02360 • Tel: 617-265-2102

Other Plants and Sales Offices in Los Angeles, Calif. 90061 • Tel: 213-532-9064,  
Hamilton, Canada • Tel: 416-529-7151; Kingston-upon-Thames, U.K. • Tel: 01-546-3384; Singapore • Tel: 374777



Circle 125 on Reader Service Card

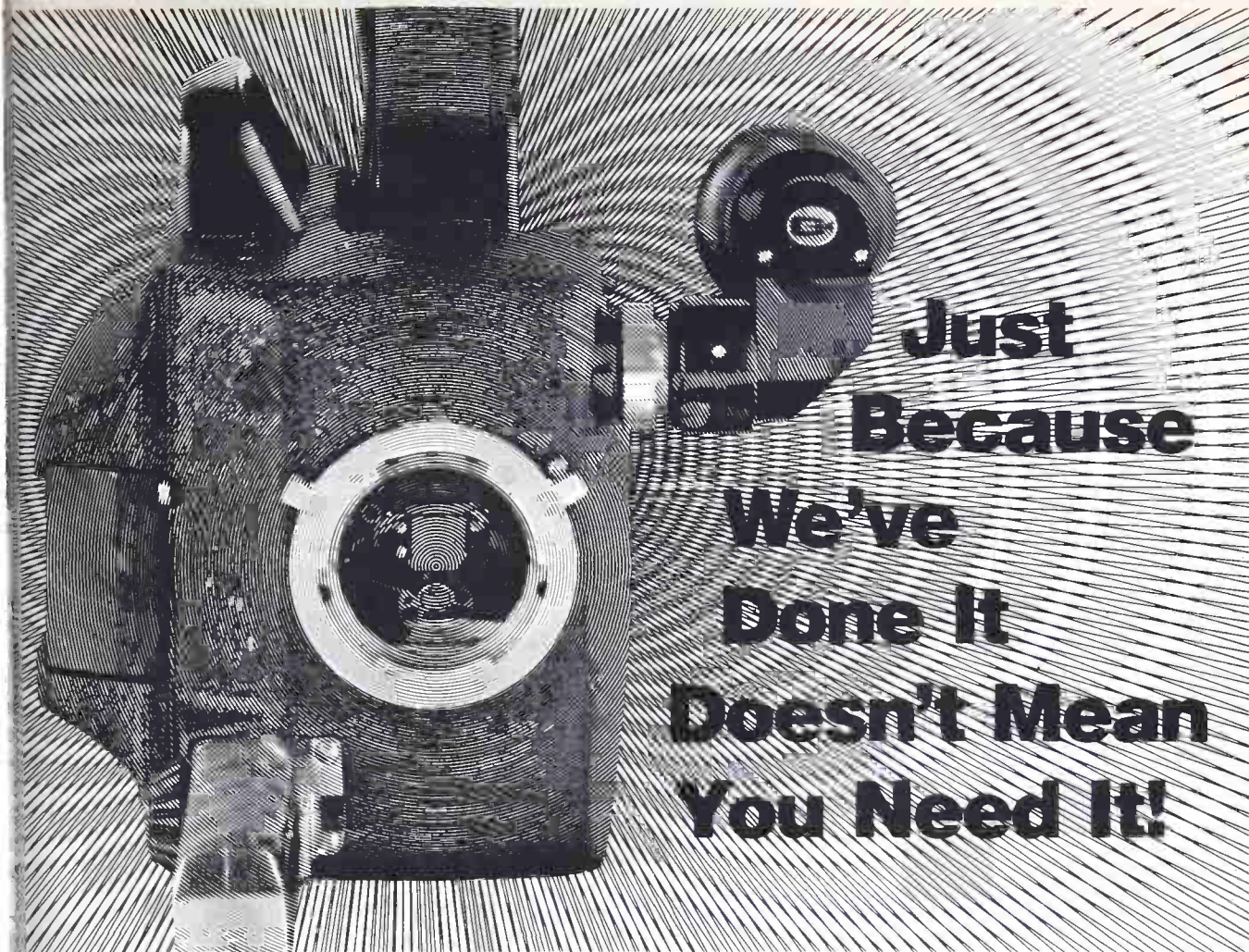

**Just  
Because  
We've  
Done It  
Doesn't Mean  
You Need It!**

Yes. We know you know we've gone ahead and reflexed the CP-16 and CP-16/A cameras. However, a reflex camera is not necessarily what you require to best handle your TV-newsfilm/documentary filming needs. Not even a reflex camera designed by Cinema Products. Let's face it. A lot of excellent and award-winning news footage has been shot non-reflex.

We believe that our non-reflexed CP-16 and CP-16/A camera models are as valid now as they were on the day that they were first introduced—two years and some thousand cameras ago. And for all the reasons that have made the CP-16 and CP-16/A the most popular and outstanding value in 16mm single system/cable system sound cameras. Successfully competing against everyone else's non-reflex as well as reflex cameras. All that's different now is that they'll be competing against *our own* reflex model as well. So you owe it to yourself to give the non-reflex CP-16 and CP-16/A camera system a thorough tryout in the field.

It may just be the very camera system that's right for you. Without upsetting your budget. After all, reflex cameras do cost considerably more. And you can go on using those expensive, long-lived zoom lenses equipped with reflex viewfinders—lenses you have so painstakingly acquired through the years.

Like we've said all along, our non-reflex CP-16 and CP-16/A cameras continue to make sense.

Equipment sense *and* dollar sense.

For further information on CP-16 and CP-16/A Cameras, please write to:

**cinema E products**  
CORPORATION

*Technology in the Service Of Creativity*

2044 Cotner Avenue, Los Angeles, California 90025  
Telephone: (213) 478-0711 ■ Telex: 69-1339 ■ Cable: Cinedevo

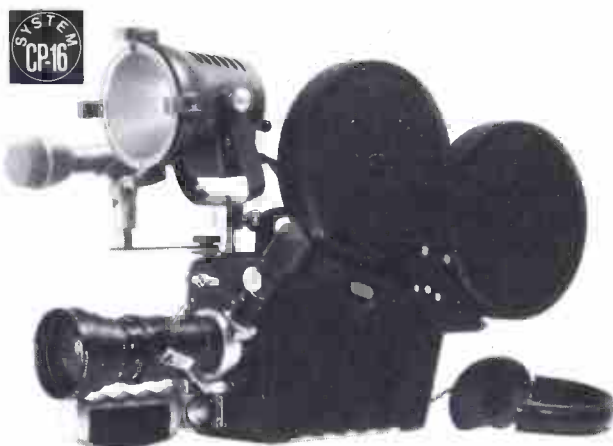

CP-16/A Camera (non-reflex) shown with Mike/Lite bracket, RE50 microphone, and Cinema Products' new *Sturdy-Lite* quartz 250 watt/30 volt battery-operated focusing spot light. The *Sturdy-Lite* focusing spot weighs only 12 ounces.

Circle 128 on Reader Service Card

## NAB SHOW-IN-PRINT

custom antenna design. Towers for antennas were promoted by Allied Tower Co., Ft. Worth Tower Co., and Utility



Emcee's new 1000-watt UHF translator was part of a line, from 1 watt up.



Allied Tower emphasized antenna towers—and their Texas home base.



Delta's digital monitor for directional antennas is one of FCC-approved units.

Towers.

Latest translator designs were shown by Acrodyne, Emcee and Rodelco. Rodelco was also showing special AM and FM transmitters.

An extensive array of power tubes for transmitters were shown by Eimac/Varian.

### Monitors, test gear: peak reading, digitized

Also stocked to overflowing for the broadcast buyer were the sections of monitoring equipment and test gear. A new kind of capability in AM modulation monitors came from Belar and McMartin: peak *measurement* (not just a quick flash when peak settings are exceeded).

Both units can indicate what the actual highest peak was. McMartin uses LED readouts which can read peaks to continued on page 76



Conrac showed new color monitors with switchable matrix, aperture correction.



New McMartin digital monitor measures peak modulation in operating intervals.

# ANNOUNCING A NEW DIGITAL Remote Control Concept

COMMAND  
 TELEMETRY

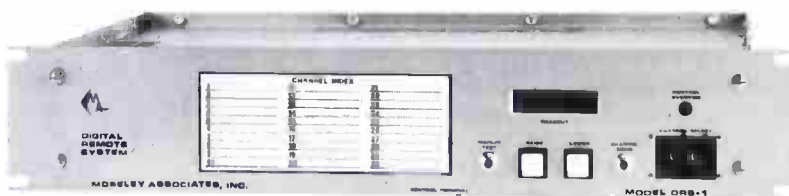

STATUS  
 LOGGING

All functions required for remote operation of a transmitter plant are provided by the Moseley Associates Model DRS-1 Digital Remote System... and completely by digital techniques. Our years of experience in the design of analog and digital remote control systems have gone into the development of this new system approach. Such features as field expansion of telemetry and command functions, wire or wireless operation, subaudible telemetry and true tally-back of channel/command functions characterize the DRS-1.

Please contact our marketing department for details on the new  
DRS-1 Digital Remote System

 MOSELEY ASSOCIATES, INC.  
SANTA BARBARA RESEARCH PARK

111 CASTILIAN DRIVE  
GOLETA, CALIFORNIA 93017  
TELEPHONE (805) 968-9621  
TELEX 658448 CABLE: MOSELEY

Circle 127 on Reader Service Card

## Tech-regulatory problems on the front burner, FCC panelists report

Automatic transmitters are popular (and the FCC hopes to open the way to them soon); delays of months and years in FCC assignments are most unpopular (and the FCC hopes to do something about that, too).

Those were just two of the subjects that stirred excitement at a joint FCC-industry panel session that highlighted the radio-television engineering assembly on Monday afternoon, March 18th, at the Convention.

On the panel for the FCC were Wallace Johnson, chief of the Broadcast Bureau; Harold Kassens, assistant chief; and Neal McNaughton, chief of FCC Rules and Standards. For industry there were Dick Monroe, Westinghouse Broadcasting, New York; Al Chismark, Meredith Corp., Syracuse; and Dan Smith, Capital Cities Communications, Philadelphia.

As it turned out, the industry representatives had comparatively little to do since the large audience was mostly interested in directing "beefs" to the FCC men, or getting clarification or reassurance from them on a variety of topics.

For example, the questioner who complained about waiting "months" on a request for a change in an FM assignment got a wave of sympathetic applause. Wallace Johnson, for the FCC, pled a severe shortage of engineering personnel as the main reason for such delays. He pointed out that there were nearly 300 requests in for unassigned FM channels, and nearly 200 for FM "drop-ins," a substantial number of them requiring complex engineering analysis. Johnson said the FCC was in a crash program to solve its personnel problems, and was also setting up a computer system, both aimed at producing relief in the near future.

The FCC got the applause for news that rules allowing the installation of automatic transmitters are in an advanced stage of preparation. Transmitter manufacturers obviously should be on the alert for the opening of a new market in this area.

Another questioner was given strong audience support when he asked what to do when he was cited for a "violation" that he believed strongly was not a violation. Johnson pointed out that his protest, which should immediately be prepared in detailed written form, could be addressed first to the engineer in charge in his district; if he got no satisfaction there, to the field bureau; then to the Broadcast Bureau in Washington; then to the Commissioners themselves. Although Johnson did not carry on further in his answer, the broadcaster, of course, always has legal action as a final resort.

With the push for re-regulation, one audience member asked, why should the FCC not return to "standards" and abandon the present "rules"? Kassens and Johnson pointed out that the FCC had found standards extremely difficult to enforce, whereas a rule has a clear regulatory character; there was no prospect of a return to standards.

An audience member got a laugh both on stage and in the audience in the course of an interchange on the new frequency monitoring rules. Kassens pointed out that it is now the carrier *frequency* that must be logged (and maintained within the assigned tolerances) rather than the *deviation*; but a deviation monitor is acceptable as a way of determining the frequency. The questioner said that his dj-operators could be taught to call for help if a deviation monitor read over 20, but if they had to add, for example, .000022 to 95.4, it wouldn't work, "no way!"

Among the dozen or so other topics that got useful airing were: the ongoing effort to make sensible adjustments for stations caught in a daylight-savings-time squeeze (treaty obligations with Canada and Mexico have complicated the FCC's action on this); more spectrum space for wireless mikes (promised); awkward results of the amended operator rules for some stations (the FCC said, please tell us your problems, we want to help); the status of the VIR signals (to be established soon, optional at first, but probably in the future mandatory as a way of improving television service); new, simplified forms (nearly ready in many cases); the success or failure of the land-mobile assignments in the TV spectrum (no complaints of interference from affected areas so far).

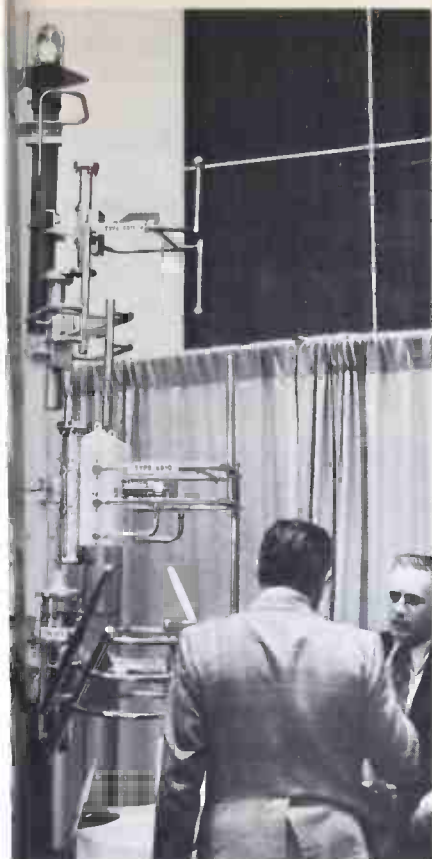

ively showed examples of their custom-built antennas for radio, TV.



A offered their color contrast evaluator in a t.



Neve had prototype of new audio console with modularized channels.

CA demonstrated proposed system for "discrete" four-channel FM.



Scully/Metrotech had line of open-reel machines.

continued on page 76

# GREAT IDEA CONTEST

Response to the Great Idea Contest has been great! But we are still anxious to get your solutions to problems for publication—and we need your votes to determine the winners of the Windjammer Cruise.

BM/E's Great Idea Contest continues to stimulate operating engineers in broadcasting to create a great reservoir of front-line engineering experience designed to meet their day-to-day and long-range problems. Each month we continue to share as many entries with our readers as we have space for.

Though all the votes haven't been counted for February, some front-runners are beginning to emerge. Leading is William Gramlings' idea for a VTR Head Clog Indicator. Myles Marks' idea for an Automatic Burst-Phase Corrector, is also running strong. There were two Audio-Follow-Video ideas, and Dennis Hills' approach, No. 11, has taken the lead. Early returns for March show Don Lidenton's Stepperless Remote Control system and C. Rees' method of recording tapes, in front.

To get the most out of this unprecedented assembly of successful reports on engineering practise in broadcasting, first **read** all the entries in this issue (and in subsequent issues) carefully: there may be something you can use. Then **vote** on the entries using the ballot on page 90, or a separate piece of paper, or write your ranking number on the Reader Service Card in the space "Tell us what you like . . ." Finally,

**send us your own ideas**, if you haven't done so already. Remember, there is no limit on the number of ideas that one contestant can submit. See the full contest rules on page 67.

Share your ideas—and get a chance at the prizes.

## 27. Hinged Patch Panel

*Terry Hoff, Asst. Chief Engineer, WPTA-TV, Fort Wayne, IN*

**Problem:** A "blind cabinet" in which a patch panel was to be installed was mounted against the wall. To install the panel in the conventional manner would mean crawling several feet inside the cabinet to reach the rear of the panel—obviously not a workable plan.

**Solution:** I came up with the idea of hinging the patch panel to swing out for access to the rear. The frame was built out of two steel strips, one hinged. The strips were placed 19 inches apart and threaded to accept a short rack screw. Fill panels were placed above and below the patch panels to give rigidity to the frame. On the side opposite the hinged side, two holes were drilled to mate with the holes behind, in the rack

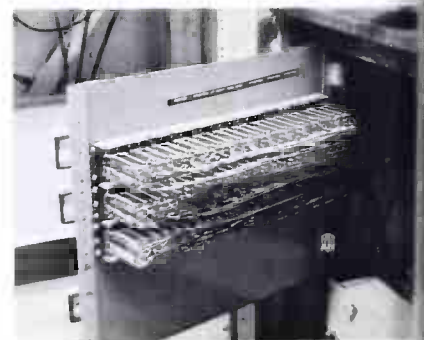
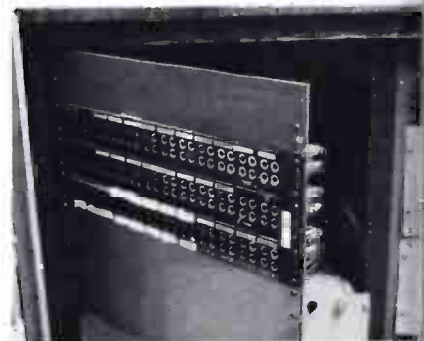
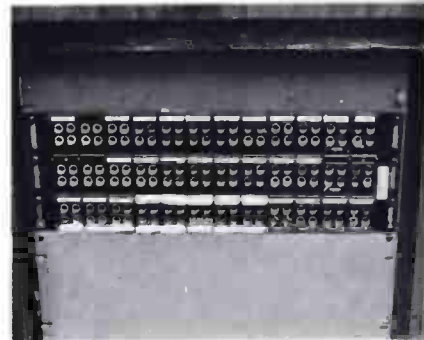

*Photos show how hinged patch panel was installed and wired.*

frame. Large thumb screws were used to hold the frame in place. This allowed easy access to the rear of the panel as well as to the adjacent equipment. I ran a cable from the back of each panel to a connection point under the console, and small diameter flexible wire was used to tightly lace back to the terminals. The project has worked well and is a most unique patch panel.



## 28. Auto-Reset Overload

Robert Oke, Dir. of Engineering, KCW, Moncton, Canada

**Problem:** To keep momentary overload from causing lost air time.

**Solution:** I designed and built this circuit in 1972 and it has been in constant use since. This circuit is used in my RCA BTA 10U transmitter: all numbers referred to are terminals in the control circuit of the transmitter. The voltage to close K-1 is obtained from the overload lamp circuit. K-2 gets its voltage through contacts of K-1 from the coil of the high voltage relay. When K-2 closes, it shorts the overload reset button removing the overload from the control circuit. The overload lamp goes out dropping out K-1, which is ready for the next overload. If the transmitter has more than one overload within the timing period of K-2, the overload circuit turns the transmitter off, removing voltage from the high voltage relay; thus K-2 cannot time out, with the result the transmitter must be reset manually.

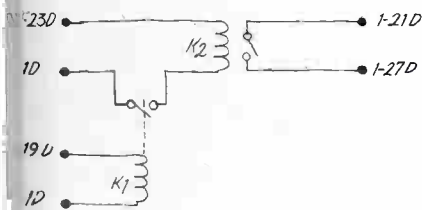

Auto-reset circuit for momentary overloads. S1 is normally open relay. K-2 has 1-min. delay on closing.

Our transmitter has only 1 overload operation before going off, but the circuit will work with any transmitter regardless of the number of overloads it makes before leaving the air. This unit has cut our off-air time from powerline surges etc., to nil, yet it still provides complete protection when there is actual trouble.

## 29. EOT Simulator for RCA Cart Machine

James McFarland, Engineer, WMTV, Madison, WI

**Problem:** The introduction of the TCR-100 into the WMTV tape room marked the beginning of greater versatility and a more professional appearance for the station. But after getting to know our machine it became apparent a

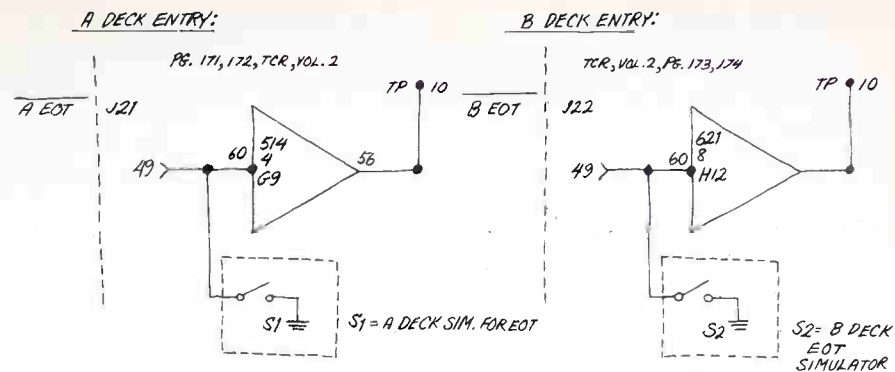

End of tape simulator modification for TCR-100 to speed clearing of decks

modification could be designed that would afford still greater flexibility. From the factory, the TCR is lacking in a good method of clearing the decks following a (reset-reject) operation. Any time it is necessary for the operator to push (reset) when in either the play or record modes, a (reject required) buss is generated, i.e., you must reject the deck or decks in question. When the reject button is operated, the transport starts forward at a standard play/record speed of 15ips. This continues until the EOT (end of tape) marker is found. At this time the tape is rewound and unloaded. This time required can be substantial. If you are operating in the A/B mode with two three-minute carts loaded, you can be six minutes from clearing both decks, and being able to load corrections or last second changes.

**Solution:** With the EOT Simulator the time required is reduced from the maximum six minutes to clear two decks, to about 20 seconds. It works whether you reset from play back or record. With the simulator installed you proceed as normal through pushing the reject button. Then you push the EOT Simulator for the deck in question and the TCR instantly enters rewind and unload, taking about 10 seconds per deck.

Two EOT Simulators are required because each deck has its own TRL (Transport Reflex Logic) and each requires its own EOT simulation. The EOT was selected as opposed to the EOM because following a reset the unit passes EOM tones and if you are in record, the EOM would be set for recording and wouldn't work. The EOT works in all modes that have the tape in motion. In fact, it can be used to reject a cart.

In making the modification, I chose the EOT buss entry points as near as possible to the operation control panel, and at a low logic level (logic 0). The

function is carried out by grounding the point or gate.

In the A deck, EOT entry is G9 60. In the B deck, H12 60. Pin one of each card is ground. The G&H in the aforementioned are logic row identifiers. The 9 & 12 refer to slot numbers. The 60 is a circuit card pin number. Logic diagrams for this section can be found in the TCR manuals page 171-174, in Vol. 2. Below I have drawn the area of each deck in which the EOT Simulators are installed. The numbers within the gate symbols are card element numbers (pc bard type id's and row slot id).

The modification I have described has been in service at WMTV for four months, and has performed without failure to date. The only parts required are a couple of momentary contact SPST switches and hookup wire. We have found it well worth while to make this change in the original design.

## 30. Telephone Operation on Talk Shows

Michael Brooks, Engineer, WTHD.WAFL-FM, Milford, DE

**Problem:** At WTHD we conduct quite a number of "live-on-air" telephone talk contests, swap shop, interview shows, etc. Faced with the usual array of telephone hand sets, head sets, transfer switches and the like, we sought a simple system to eliminate the need for our non-technical operators to do anything to place a call "on-air" other than the operation of the control room "beeper pot" and punch up the desired phone line.

At the same time we were also looking for a solution to prevent the degradation of the quality of the announcers voice when used in conjunction with

Continued on page 66

## GREAT IDEAS

the limited response of telephone head sets or desk sets.

Also we wanted to solve the recurrent problem of incoming callers being unable to hear the pre-delayed voice of the operator-DJ, which occurred when talking to a distant hand set or desk amp.

**Solution:** The accompanying schematic shows the system we developed. The idea was to take a feed from the control room microphone through a resistive bridging network. The only trick involved was the use of a relay to disconnect the amplifier microphone signal from the telephone when the control room mic. pot is in the neutral position.

Note that a switched feed could have been taken from the control board. However, to preserve our low level of hum and noise and freedom from switching transients it was decided to avoid any "piggy-backing" or "jerry rigging" inside the master control board if possible. Hence we developed the relay interrupt circuit, driven by the "on-air" tally circuit.

Some jockeying of levels was necessary to match the wide range of phone line levels on incoming calls. It was also decided to give the announcer an "edge" of approximately 6dB over the incoming callers to maintain dominance with the help of our normal program AGC system.

In the end we achieved the desired results while spending a minimal amount of money to do the job. The system is simple and yields no detectable difference in the quality of the announcer's voice whether on mike or phone. We also ended the callers' complaints of inability to hear the announcer on a pre-delay basis.

### 31. Off-Air Pickup for Network TV.

*Ernest W. Davis, Jr., Chief Engineer, WRFT-TV, Roanoke, Va*

**Problem:** The WRFT-TV, Roanoke, Virginia, transmitter site is located on Poor Mountain with an elevation of 3760 feet. For economic reasons, it is necessary to use an off-the-air pickup for our network program source. This pickup is WGHP-TV, High Point, North Carolina on channel 8. A satisfactory signal is not available at the studio location due to the dis-

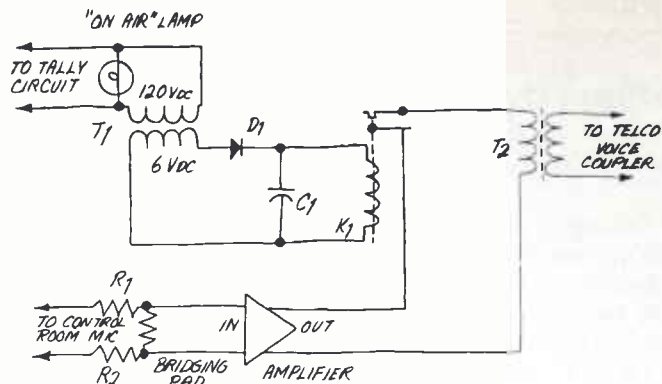

*This multi-purpose circuit developed by Brooks for telephone operation (No. 30 preceding page) puts call on air when mic pot is turned off neutral. There is no jerry-rigging of control board hence hum level is low.*

tance, which is 95 miles.

Since the transmitter is on remote control and a usable signal is available, it was decided by Andy Petersen, the general manager, that the receiver would be located at the transmitter site and the network-local switching could be accomplished by relays operated by the remote control unit.

The receiving system for channel 8 is a Dynair Demodulator fed with a pass band filter which eliminated all of the normal adjacent channel problems created by channel 7 being located one half mile from the receiver. The original antenna was a double stacked Yagi located near the ground and at the end of the building, which is broadside to channel 8 to minimize channel 7 pickup.

During the first year of use two frequent problems occurred. When the channel 8 signal faded downwards the video, although satisfactory in other re-

spects, would contain a thin outline film of the channel 7 color modulation products when they were transmitting color near saturation. This lower adjacent channel color modulation has been on occasion at a level great enough that, for instance, an I.D. slide could be plainly read as it floated over the channel 8 video. The other problem occurred during the first winter. While the Yagi antenna system was normally satisfactory, heavy icing, which is frequent at this location, would completely cancel the signal.

**Solution:** In order to resolve these problems it was apparent that two steps were necessary. The antenna system would have to be protected from the environment to prevent ice formation and the channel 7 signal would have to be reduced.

After considering all types of antennas, the one type most suited to this application would be a collinear array



*Four-element collinear antenna or wood frame, left, is protected from ice by plywood shed, right.*

## GREAT IDEAS

A four element prototype was constructed with a wood frame and brazing rods cut to one half frequency. The metal building would serve as the reflector. The test results were that the signal level from channel 8 was satisfactory and the antenna could be easily protected since it was only .2 wave length from the building. The shed in which the antenna would be protected could be painted with aluminum paint to serve as a shield to the channel 7 signal which is located 90 degrees to the right of the channel 8 direction.

The antenna was constructed and enclosed in a shed made with 4 x 8 plywood roof and sides at a cost of \$50.00. The results have been that the cing problem has been completely eliminated and the adjacent channel interference has been reduced to 20% of the previous value.

## 32. Transferring News to Machine Cart

Leonard A. Burns, Chief Operator, WLDR, Traverse City, MI

**Problem:** How to get the best possible transfer (audio) from the news reporter's tape machine to station cartridge equipment.

**Solution:** Usually the best playback machine is the one that the material was originally recorded on. With that in mind, I constructed a pocket patch cable that even non-technical minded station personnel can use without error. The cable consists of a pair of heavy duty clip leads (color-coded) wired to a triad JO-3 input transformer which is connected to a two-conductor miniature plug. Since inputs to our sparta production board are 600 ohms, a good impedance match is necessary for proper frequency response and correct program level. The patch accomplishes this easily.

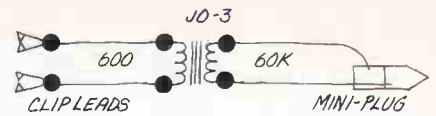

Diagram above, pasted on transformer, shows newsman how to connect clip leads for dubbing from tape to cart.

To use this device the editor need only connect the red and black clip leads per the mini-diagram pasted on the transformer. This involves disconnecting any of the other tape inputs and connecting the clip leads to the two-conductor plug. Many engineers will notice that such a device could be easily wired-in permanently if the board has sufficient provisions for inputs. After making the connection to the board input lead, the operator then simply plugs the miniature plug into the tape player. It sure beats holding the cassette player up to the microphone and recording onto reel tape then onto cartridge.

Continued on page 89

### Rules for BM/E's Great Idea Contest

- 1. Eligibility:** All station personnel are eligible. Consultants to the industry may enter if the entry indicates the specific station or stations using the idea or concept. Manufacturers of equipment or their representatives are not eligible.
- 2. How to Enter:** Use the Official Entry Form on this page or simply send BM/E a description of your work. State the

objective or problem and your solution. Include diagrams, drawings, or glossy photos, as appropriate. Material must be legible but need not be directly reproducible—although camera-reproducible material is preferred. Length can vary, but should not exceed 1000 words. BM/E reserves the right to edit material. Entry should include: Name, title, station affiliation, and the class of station—TV, FM, AM (Class I or II), or AM (Class III or IV). Indicate if idea is completely original with you.

**3. Material Accepted for Publication:** BM/E editors will make all decisions regarding acceptability for publication. If duplicative or similar ideas are received, BM/E editors will judge which entry or entries to accept. A \$10 honorarium will be paid for each item published.

**4. Voting.** Every reader of BM/E is entitled to rank the ideas published. This can be done on the ballot in the magazine or by letters or cards sent to the BM/E office. A reader can judge one or all ideas published. Readers must assign a point score to each idea on a scale of 0 to 10; e.g., if you think an idea is excellent, score it 10; if you think it is without merit, score it 0; if you like it but want to discriminate, pick the appropriate number between 1 and 9.

**5. Winners.** Relative ranking of each month's entries will be published after 60 days. Top-rated entries for various categories will be republished in December 1974 for a second and final round of scoring. Final winners will be picked in February 1975 and notified by mail. Winners will be published in the March 1975 issue of BM/E.

**6. Prizes and Awards.** Four top prizes will be awarded—each a six-day cruise for two on a Windjammer in the Caribbean.\* Cruise awards will be one each in categories of TV, FM, AM (Class I and II), AM (Class III and IV). In addition, highest ranking entries will receive a BM/E Certificate of Merit award, one each for the following nine categories: TV, RF; TV, Video; TV, Audio; FM, RF; FM, Audio; Class I and II Radio, RF; Class I and II Radio, Audio; Class III and IV Radio, RF; Class III and IV Radio, Audio.

\*Between months of May to November, choice of cruises: Bahamas, Virgin Islands, West Indies. Deck Cabin accommodations. Travel to and from port cities of Miami, San Juan, or Virgin Islands not included. Authors of top-ranked items will receive Windjammer Cruise information in November 1974.

### Entry Form for BM/E Great Idea Contest—1974

Mail to: Editors, BM/E  
274 Madison Avenue  
New York, New York 10016

Name \_\_\_\_\_ Title \_\_\_\_\_

Station Call Letters \_\_\_\_\_

Address \_\_\_\_\_

City \_\_\_\_\_

State \_\_\_\_\_ Zip \_\_\_\_\_

Licensee \_\_\_\_\_

Class of Station: TV \_\_\_\_\_ AM (Class I or II) \_\_\_\_\_  
FM \_\_\_\_\_ AM (Class III or IV) \_\_\_\_\_

Title of Entry \_\_\_\_\_

**Objective or Problem:** (in few words; use separate sheet for details) \_\_\_\_\_

**Solution:** (use separate sheet)

I assert that, to the best of my knowledge,\* the idea submitted is original with this station; and I hereby give BM/E permission to publish the material.

Signed \_\_\_\_\_ Date \_\_\_\_\_

\*If you feel credit for prior work or antecedents should be given to someone outside of the station, indicate to whom and when.

# Scully Shows You How To Be Perfect Without Paying The Price.

As a professional, you want the finest in a professional recorder. The best sound reproduction possible. Simplicity of operation. Reliability coupled with ease of maintenance. And, you don't want to pay a fortune to get it. In short, you want perfection at a perfect price. You want the new 280-B Recorder/Reproducer.

## Unmatched Performance.

By designing the 280-B electronics around the new high-energy tapes. The S/N ratio is perhaps the best available in any recorder at a comparable price. Up to 72 dB on full track .25" tape at mastering speed. A sharp 68 dB on two-track .25" and four track .50"

The 280-B also features more head room and an increased record level for maximum signal utilizing the high output tapes. And bandwidths are a very flat  $\pm 2\text{dB}$ , 30Hz to 18 KHz. It all adds up to greater performance

than you've ever been used to.

## Quick, Simple Operation.

The more sophisticated we've made the 280-B, the simpler we've made it for



you to operate. Our new **Optac**<sup>™</sup> motion sensing system gets a new standard of efficiency in tape motion control. Now you can go from one transport mode to another without touching the Stop button. And enter and leave Record while the

transports in Play. **Optac**<sup>™</sup> and the 280-B's new logic circuitry make the exact moves for you at the right time.

## Easy Maintenance.

New solid state circuitry and mother-daughter board architecture give the 280-B a greater reliability factor. They also make testing, repair and replacement easier. All signal electronics are in slide-out drawers. No more bending down and reaching around. Individual channel modules go in and out easily, too.

If the 280-B sounds too good to be true, wait till you hear it. And wait till you find out the price. We've made it very easy for you to get the best.

For more detailed information and prices on the 280-B, call or write: Scully/Metrotech, 475 Ellis Street, Mountain View, California 94040. (415) 968-8389. TLX 345524.

▶ **Scully/Metrotech**  
Recording Divisions of Dictaphone

\*Scully/Metrotech and Optac are registered trademarks of Dictaphone Corporation, New York, U.S.A.

# BROADCAST EQUIPMENT

**Nylon self-locking cable ties** will bundle cables, wires and hoses from 1/16-in. to 8 1/8-in. dia. Nytyes® can be assembled by hand or tool and are available for regular duty, heavy duty and mountable applications. **MEYMAN MANUFACTURING CO. 302**

**Video analyser** checks television waveforms by displaying them directly on the screen of an ordinary TV monitor. The model 350 samples video information to generate a low frequency waveform and then uses a proprietary pulse position modulation technique to convert the waveform to television format. \$400. **COLORADO VIDEO. 302**

**Tape transport** with electronic controls and interlocking remote control via TTL signals features lapsed tape running time indicated in minutes and seconds on an LED display. The Studio Light recorder handles 1/4-in. tape on IAB or cine-type reels up to 10 1/2-in.



Two servo-motor-controlled tape speeds of 15 7/8 and 7 1/2 ips are available. Frequency response is 30-20 kHz ± 2 dB; S/N ratio is claimed to be better than 66 dB. **FERROGRAPH. 301**

**Combination compressor, limiter and expander** provides optimum level for maximum modulation power and coverage without danger of overmodulation. Signal processing is smooth and quiet without distortion, pumping or background noise. Gated automatic gain control amplifiers and fast-acting peak limiters are used in the model LE-500 Sound Britener. Automatic self-controlling functions within the CLE-500 eliminate the need for

several companion units. A 3-in. meter indicates expansion and compression, while indicators signal low-signal level and power. The input level accepts normal program levels over a 50 dB range, while the output level matches any 600-ohm transmitter or line. **BROADCAST ELECTRONICS. 303**

**Shipping reel** is designed to drastically reduce freight costs for the feature film industry. The 2000-ft. reel, made of Plio-Magic, is claimed to be as tough as



steel but 60% lighter in weight. The plastic reels are practically indestructible and highly resilient which makes them resistant to bending, breaking, and binding. They are priced to pay for themselves in just three to five shipments, depending on distance. **PLASTIC REEL CORP. OF AMERICA. 318**

**Videocassette cabinet** stores 14 cased U-Matic videocassettes. The steel units are stackable up to 5 units high, or can

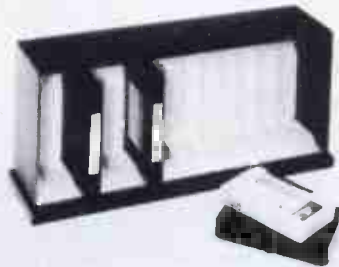

be wall-hung. Dubbed the model V-14, these 17-lb. cases are 13-in. x 8-in. x 30-in. \$30. **WINSTED CORP. 331**

**Color bar generator** features R,G,B,I, and Q outputs in standard split-field NTSC configuration. Full-field bars only, full-field I, white and Q-only are also available via front panel switches. Model 900 utilizes TTL logic throughout. \$975. **DIGITAL BROADCAST SYSTEMS. 304**

**Digital stopwatch** is a compact panel-mounting instrument for measuring elapsed time intervals from hours down to microseconds. It features a bright LED display, data outputs, and remote control inputs. The Slimline Stopwatch is used for measuring tapes, timing program segments, and for general studio and control room use. Data outputs are parallel 1248 BCD. TTL/DTL compatible, and a read strobe is provided to indicate the validity of data at the outputs. The remote control inputs for start, stop, and reset are also TTL/DTL compatible. The Stopwatch operates from 5 VDC; line-frequency timebase models require 60 Hz reference (50 Hz optional). \$208-\$286. **NATIONWIDE ELECTRONIC SYSTEMS. 323**

**Programmable delay sections**, housed in a metal box with BNC connectors, permits video delay from 5 ns to 4,500 ns. The degree of accuracy



required can be either steps of 5 ns or 100 ns. Impedance of the UN068 matches 75-ohm lines. **MATTHEY PRINTED PRODUCTS. 309**

**Air-cooled 25 KW UHF TV klystron** has permanent magnet focussing. Other features of the type Yk1151 are: high efficiency at full power as well as at half-power operation (approx. 40% efficiency); greater than 40 dB gain (requires less than 2.5 watts of drive); built-in ion pump for long life. **AMPEREX ELECTRONIC CORP. 329**

Send only  
the best.



The new CLD-1100 Sync Pulse Generator from CBS Laboratories features digital-circuit design. Unique design enables maximum adaptability in pulse systems and achieves virtually perfect timing between dissimilar studios. Unit stability is derived from a timing circuit employing a single servoloop where the 3.58 MHz color frequency is generated from a 14 MHz crystal reference source. Contact us for quotes on your new sync systems. From CBS Laboratories, of course.

## CBS LABORATORIES

A Division of Columbia Broadcasting System, Inc.  
227 High Ridge Road, Stamford, Connecticut 06905

Circle 138 on Reader Service Card

# FCC Rule 73.69 + \$1660 = AM-19(204)

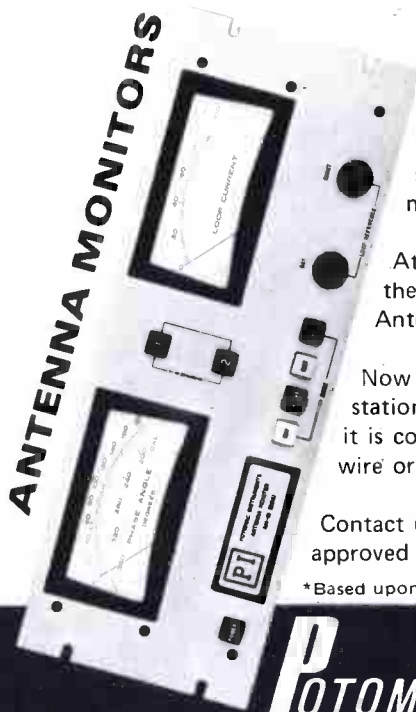

The FCC now says that you must have an approved Antenna Monitor. Since this is an added expense, consider carefully what is required of the monitor versus what it will cost.

At \$1660\*, the Model AM-19 (204) is the lowest priced, FCC type approved Antenna Monitor available.

Now after several years of use at many stations, it has proven its reliability. And, it is compatible with virtually every type of wire or wireless remote control system.

Contact us now on this and other FCC type approved Antenna Monitors.

\*Based upon 2 tower, DA-2.

## POTOMAC INSTRUMENTS

932 PHILADELPHIA AVE.  
SILVER SPRING, MARYLAND 20910 (301) 589-3125

Circle 139 on Reader Service Card

## PRODUCTS

**Audio control console**, aimed at the television broadcaster, incorporates all the design features of the popular model 1204 recording studio console. Features of the model 1204 TV include eight monitor muting switches which help prevent feedback from studio m



crophones; direct feed switching which bypasses the VUs assignment and output sections of the console; two special input channels each accept 11 line-level pushbutton switchable sources. Other features include four mixing buses, Sub 1, Sub 2, AUD and PGM, which may be used for simultaneous development of different mixes; exclusive 9-frequency graphic equalization; stainless conductive-plastic faders; redundant power supply reset and indicator system; and echo chamber send available on each input channel. CETEC.

**Catv multiple dwelling installation** product line consists of eight home run systems, six types of amplifiers, directional taps, and all necessary accessories for total system capability. AV ELECTRONICS.

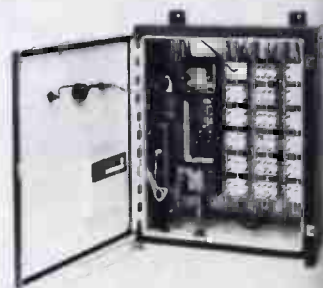

series for total system capability. AV ELECTRONICS.

**Upgraded hybrid trunk and feed amplifier series** is compatible with present Theta-Com XR2 series. Significant improvements are said to be designed into the new line of XR2-P series. These include improved cross modulation and signal level capability for both trunk and bridger amplifiers. An improved noise figure for both MGC and AGC trunk amplifiers has been made possible through the use of low noise discrete input stage. An

continued on page

# MICROTIME!

## A great group with more great cures for TV jitters.

Introducing the MICROTIME™ family of video signal processing systems and accessories. They eliminate picture rolls, tearing, flag waving, hue shift, skew error or color streaking. Developed and built by a great group of people... who developed and built our successful Delta Series Time Base Correctors.

Since no one product can solve all problems, we have an entire family of TBCs and accessories:

### MICROTIME

- 100 Series LU-MATIC Monochrome TBCs
- 200 Series CHRO-MATIC NTSC Direct Color TBCs
- 300 Series NTSC HETROCOLOR Universal Color TBCs
- 400 Series PAL-M HETROCOLOR Universal Color TBCs
- 600 Series DIGI-MATIC Wide Aperture NTSC Color TBCs
- 700 Series VELCOR Velocity Error Correctors

For handling those wild and wiggly signals from low cost VTRs with large tension error, we've added the DIGI-MATIC™ Wide Aperture TBC.

To integrate low cost VTRs... dubbing up to broadcast, and sophisticated post-production processing... we're offering this bushel of new accessories:  
VSD-30 Input Sync Gen/Switcher Accessory to TBC  
DVP-40 Output Switcher/Fader Accessory to TBC  
SL Series SYNC-LOC Servo Accessories for VTRs

When you stack us up against our competition, we will be the apple of your eye. Because we are the leaders in video signal processing systems, a step ahead of everyone else. Get all the facts. Write for our brochure, today.



**Television Microtime, Inc.**

1280 Blue Hills Avenue, Bloomfield, Conn. 06002  
(203) 242-0761

Available from leading television distributors  
throughout the United States and Canada





the first  
reel to reel  
with the rugged  
reliability of  
**itc**

The makers of premium quality tape cartridge equipment in the reel-to-reel market? It had to happen! The result is what you, Mr. Broadcaster, have been looking for. All the features you demand plus a few innovative optionals of our own. And all with the rugged reliability inherent in the International Tapetronics' name. Check out these plusses in your own studios. We offer a 30 day guarantee of satisfaction plus a one year warranty. Just call collect and say you want to try the "850" series. We'll do the rest.

Phone 309-828-1381



**INTERNATIONAL  
TAPETRONICS CORPORATION**

2425 South Main Street Bloomington, Illinois 61701

Marketed exclusively in Canada by  
McCurdy Radio Industries Ltd., Toronto

Circle 141 on Reader Service Card

**PRODUCTS**

tional DC power supply for use in the trunkline amplifier features a switching-type circuit. The new power supply will also accept a DC voltage input from the cable system coax. THETA-COM. 306

**Remote console** combines the features of an integrated portable originating system with modular expansion capability for broadcasting remotes. Up to seven inputs to mix bus. Other features

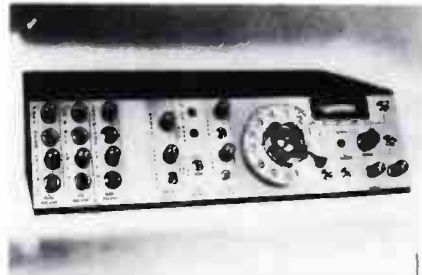

include: headphone monitor or automatic hang-up options; two-way communications through phone lines; input options such as low- and high-Z mikes, phono cartridge, tapehead and line level. The console is designed for use through loops, local and long distance lines. PULSE DYNAMICS MANUFACTURING CORP. 335

**Fluid head** accommodates studio-type motion picture cameras and television cameras weighing up to 150 lbs. Made of magnesium and weighing on 25 lbs., the 150XR Fluid Head features completely independent variable pan drag adjustment and tilt drag adjustment,



with separate dial indicators showing the amount of drag on each movement. A 5-in. x 6-in. removable camera mounting plate which can be permanently mounted to the camera, permits the camera to be snapped instantly in place and adjusted forward or back-



**Stanton creates  
the new calibration  
standard ....  
the 681 TRIPLE E**

A definite need arose.

The recording industry has been cutting discs with higher accuracy to achieve greater definition and sound quality.

Naturally, the engineers turned to Stanton for a cartridge of excellence to serve as a primary calibration standard in recording system check-outs.

The result is a new calibration standard: the Stanton 681 TRIPLE E. Perhaps, with this cartridge, the outer limits of excellence in stereo sound reproduction have been reached.

The Stanton 681 TRIPLE E offers improved tracking at all frequencies and achieves perfectly flat frequency response beyond 20 Kc. It features a dramatic reduced tip mass. Actually, its new natural diamond is an ultra miniaturized stone only 2/3 the mass of its predecessor. The stylus assembly possesses even greater durability than had been previously thought possible to achieve.

The Stanton 681 TRIPLE E features a new design of both cartridge body and stylus; it has been created for those whom the best is none too good.

Each 681 TRIPLE E is guaranteed to meet its specifications within exact limits, and each one boasts the most meaningful warranty possible: an individual calibration test result is packed with each unit.

Write today for further information: Stanton Magnetics Inc., Terminal D, Plainview, New York 11803.



**STANTON**

All Stanton cartridges are designed for use with all two and four-channel matrix derived compatible systems.

Circle 142 on Reader Service Card



**PRODUCTS**

ward to accommodate different lenses and film weights. \$2400. CINEMA PRODUCTS CORP. 316

**Miniature electret capacitor microphone** with 140 dB omnidirectional sound level capability is claimed to have  $\pm 3$  dB frequency response of 40 to 16,000 Hz. Distortion is said to be less than 0.3% at 100 dB SPL. Other specs for the model SD140-Z: usable



dynamic range of 113 dB, negligible susceptibility to vibration, hum, RFI, temperature and humidity. Microphone element measures 1/4-in. x 1/4-in. x 1/8-in., and comes mounted on a 10-in. long aluminum tube with foam blast screen. Power is supplied via a 9V transistor radio battery housed in a remote power module. Termination is via XLR-3 termination; balanced output works into any output from 50 to 600 ohms. \$189 GROUP 128. 312

**Digital AM peak modulation indicator**, designed to supplement type approved AM modulation monitors, measures and indicates AM modulation peaks instantly and accurately. LEDs



read both positive and negative modulation peaks. The TX-800 operates directly from RF and reads peaks to an accuracy of 1%, and provides logging outputs for connection to digital printers and logging systems. \$975. McMARTIN INDUSTRIES. 320

**Canon IOx UNIVERSAL ZOOM**

One-Inch Plumbicon Color Camera Zoom



PV 10X15

**15 mm to 150mm; f/2.0**

- Wide Angle
- Close Focusing 3.9'
- Bayonette Mount
- Adjustable Back Focus
- "Macro Focus" Operation
- Small Size
- Lightweight
- Light Transmission Over 80%
- For All One-Inch Color Cameras

**Canon**  
BROADCAST OPTICS

CANON U.S.A., INC., 10 NEVADA DRIVE, LAKE SUCCESS, N.Y. 11040  
(516) 488-6700

Circle 143 on Reader Service Card

**IS THERE A LIMIT**

**to what we can do for your AM sound?**

**We can't rebuild your transmitter, we can't set your program format—  
But we can help your AM sound!**

Ask Charlie Mallett of KCBQ in San Diego

Ask Hugh Beavers of KRIZ in Phoenix

Ask Jim Noble of KLAC in Los Angeles

**They have the new Modulimiter with Automatic Polarity Correlator. They like their "new sound."**

**Do we promise miracles? No, but we do promise help for your AM audio chain. Sharper sound, cleaner positive modulation, better voice presence, and more punch for your format!**

**"Call us today. We'll talk with you—and work with you, to help you get that "new sound."**

PACIFIC RECORDERS AND ENGINEERING CORPORATION  
11760 SORRENTO VALLEY ROAD, SAN DIEGO, CALIFORNIA 92121  
TELEPHONE (714) 453-3255, TELEX 695008



Circle 144 on Reader Service Card

# Replace Mercury Vapor Tubes Directly with



# WILKINSON Silicon Rectifier Stacks! Because...

- Only non-encapsulated WILKINSON Silicon Rectifiers can be repaired in seconds with low-cost replacement diodes!
- Exclusive "GO, NO GO" indicator automatically warns when the reverse leakage of any diode is in excess of 50 microamps.
- Only WILKINSON Silicon Rectifiers are available in a complete tube replacement range of from 866 to 857B.
- WILKINSON Silicon Rectifiers function in ambient temperatures of from - 85 F to +158 F.
- No more filament heat and consequent filament burnout... lower power cost and reduced hum, too.
- No warm up time is necessary... instantaneous operation!
- Just plug in WILKINSON Silicon Rectifiers... no re-wiring is necessary.
- Only WILKINSON Silicon Rectifiers are fully guaranteed and have a safety margin well in excess of tube rating.

For complete details write today to:

## WILKINSON ELECTRONICS, INC.

1937 MACDADE BLVD. WOODLYN, PA. 19094  
TELEPHONE (215) 874-5236 874-5237

Circle 145 on Reader Service Card

## NEWS continued from page 14

between the two . . . RCA television broadcast studio equipment valued at approximately \$395,000 has been ordered by WPRI-TV, Providence, RI, as part of the station's complete modernization program . . . Ampex Corp., was awarded two contracts totaling more than \$1.45 million, with the National Iranian Radio and Television Organization (NITRO), for equipment to be used in radio and television coverage of the Seventh Asian Games in Tehran, Iran, Sept. 1-15.

Blonder-Tongue Laboratories, Inc. has created a new Product Engineering Section, to provide a quick-reaction design capability, fast response to special and custom product requests, and to implement state-of-the-art advances in existing products. Albert E. Schmidt is manager of the new section.

London Weekend Television has become the first commercial broadcasting company in Europe to adopt the BIAS system of computerized radio and TV advertising traffic and management information control, of Data Communications Corp. . . . RCA Broadcast Systems has established a new TV control equipment organization to expand current product lines and to provide design and development di-

rection for automated devices and systems planned for the future. Henry H. Klerx is manager, control equipment engineering and product management.

RCA Alaska Communications, Inc. is developing and installing approximately \$30 million in communications systems to serve the construction and operation of the trans-Alaska oil pipeline . . . KSD-TV, St. Louis, became the first station in the U.S. to cover fast-breaking news with a complete 1/4-inch AKAI color video tape system . . . Cerro Corp. has acquired the business and assets of View All Television Products Corp., a major supplier of CATV devices.

Kaman Sciences Corp. has added KCMO-TV and WPEC (TV) to the roster of stations using its Broadcast Computer Services . . . GTE Sylvania's CATV Equipment & Installation Operation received a contract from Heritage Communications, Inc. for construction of an 800-mile cable television system to be operated in the Des Moines metropolitan area.

## Programming

"We Call Them Brother," an 18-minute motion picture dramatizing the plight of endangered animals threatened by extinction, is now available for showing, free of charge from Eastman Kodak Company . . . "Can

the new

### MCMARTIN / BA-1K 1000/500/250 watt AM

BA 1K-the perfect transmitter for your new AM station or updating your existing operation

FCC TYPE ACCEPTED

unique interior accessibility front and rear

all solid state except for four 4-500A power tubes

125% positive peak capability

pushbutton Hi-Lo power operation

full remote control/metering capability

power driven vacuum variable tuning/loading controls

built-in dummy load

from the "FULL-CHOICE" line

## McMartin.

McMartin Industries, Inc. 4500 South 76th Street, Omaha, Nebraska 68127 (402) 331-20  
Circle 146 on Reader Service Card

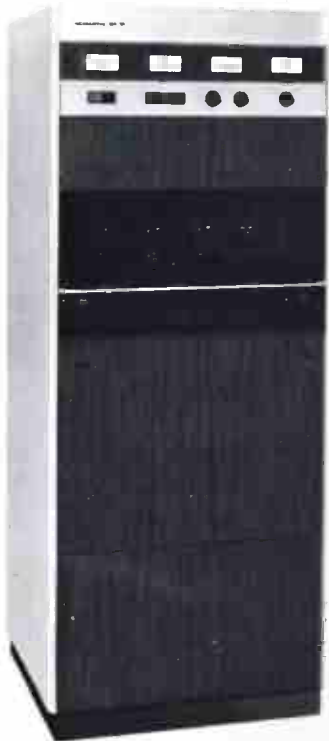

# transmitters

**You Imagine?"** is a new color literature series for grades 3 and 4 designed to make the student *want* to read. Available for lease/purchase from Great Plains National Instructional Television Library.

Two new special interest services—**"Arts, Crafts and Hobbies"** and **"Travel/Outdoors"**—have been added to the programming of Home Box Office, cable pay TV network.

**Children's Television Workshop (CTW)** is developing a 26-program series of hour-long health information programs for showing on public broadcasting stations. Geared to young adults, the series developers have interviewed over 250 physicians and health officials and held numerous seminars to ascertain major subject areas and means of treating these subjects on TV.

This spring, the full season of **11 NCAA Lacrosse games** is being televised for the first time. The schedule includes the NCAA quarter final, semi-final, and final championship games, as well as the North/South All Star game. TV Production and direction is being done by Sheldon Shemer of Sports Media, Inc. Schaefer Advertising Inc., Bala Cynwyd, Pa. is sales agent for the TV series. **GRT Corp.** has acquired exclusive North American rights for **"The Bible,"** a 12 disc package of dramatic readings by Sir Lawrence Olivier of passages from the Old Testament backed with orchestral and choral music.

The Explorer Scouts in Pampa, Texas, who have been entirely responsible for programming local cable PCTV-CH 9 since late 1972, covered the **Texas Constitutional Revision Convention** in Austin, Texas this year.

**NCTA Show-In-Print will appear in CM/E section; June 1974.**

## People

**Peter W. Frame** was appointed marketing services development director, and **William G. Hooks** was named field sales director, for Home Box Office, Inc. **Jack H. Oetgen** was elected chairman of the board of trustees of the Protestant Radio and TV Center, Atlanta, Georgia.

**Paul Hart** of TPT Manhattan and **Richard Downie** of Sterling Manhattan cable TV systems won "Outstanding Achievement" awards as the highest scorers in the Electrical Lineman (CATV) Joint Apprenticeship Program set up by the two cable companies and Local #3, International Brotherhood of Electrical Workers, and funded by the New York State Department of Labor.

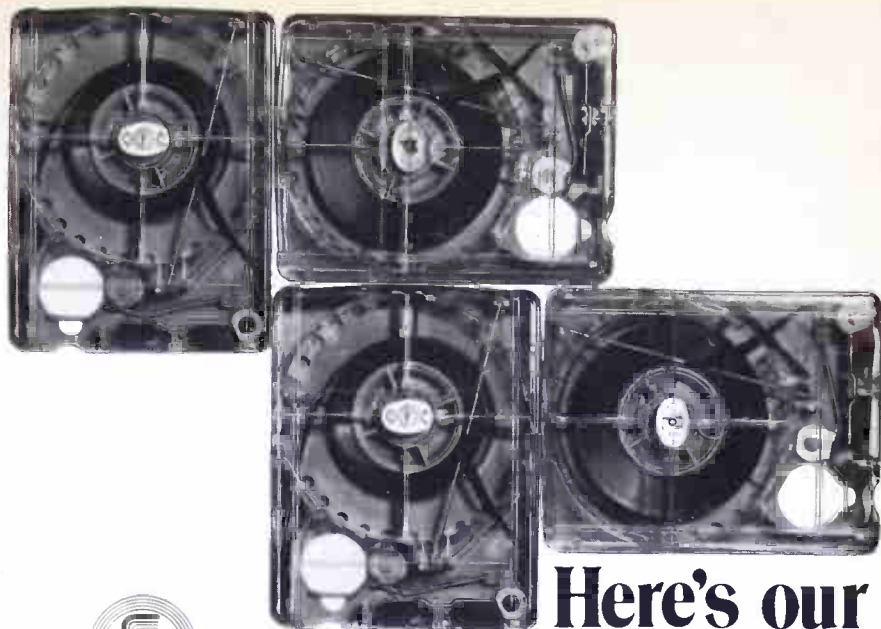

## Here's our story...

Want more? Contact your Fidelipac Distributor and learn why more Fidelipac Automatic Tape Cartridges are in use throughout the world than all others combined.

# FIDELIPAC®

3 Olney Avenue • Cherry Hill, New Jersey 08034 • (609) 424-1234  
Fidelipac is a registered trademark of TelePro Industries Incorporated

Circle 147 on Reader Service Card

## PORTA-PATTERN®

PORTA-PATTERN Optical Test Generator products designed to provide the finest television industry standards in Test Charts, Slides and Films.

Precision 9" x 12" test charts recessed in high-impact Acrylic, designed for long life; provided in lightweight aluminum frame for use free-standing, on mic or light stand. Full line of B&W and color charts for complete flexibility.

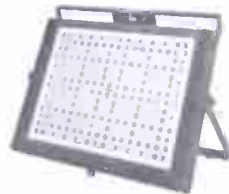

Full line of geometric and color transmission test slides in 2" x 2" or 3 1/4" x 4" format. B&W slides available positive or negative. Advanced photo-chemistry assures 1/10 of 1% accuracy. Available individually or in full sets.

Super 8mm & 16mm alignment films, for projector stability and image accuracy. Color Reference films provide standardization of subjective reference throughout system. Slides and films produced to meet or exceed industry standards.



For full specifications and prices contact:



TELECOMMUNICATIONS INDUSTRIES LIMITED  
414 No. Alfred St., Los Angeles, California 90048, U.S.A.  
(213) 651-0480

Circle 148 on Reader Service Card

## NAB SHOW-IN-PRINT

continued from page 63



Time and Frequency Technology's new stereo monitor, on modulation monitor.

an accuracy of 1%. The highest reading received during a convenient interval of time is stored in a memory which re-freshed the LEDs.

The Belar system has a series of five lights in-line on either side of an adjustable "normal." If the normal was set by a thumbwheel to say, 120%, and the peak positive was one percent above that, the first light on the right of normal would go on. If the peak was 5% over, the fifth light to the right would illuminate, etc. (For peaks between 115 and 120%, lights on the left would go on.)

McMartin's TX-800 is intended as a

supplement to a regular modulation monitor; Belar's unit is a complete monitor in itself. Both use digital techniques to measure and indicate the peak readings.

Another new kind of modulation monitor came from Time and Frequency Technology: their Model 724 phase-locked loop stereo monitor, intended to be added to their Model 723 frequency and modulation monitor for complete coverage of FM stereo monitoring requirements. The Model 724 reads separate left and right modulation, separation, crosstalk, signal/noise, pilot frequency (in digital display).

TFT, along with Belar, Wilkinson, McMartin, also showed their familiar lines of AM and FM modulation and modulation/frequency monitoring equipment.

# Prove to yourself what other broadcasters already know.



RP Series Recorder/Reproducer



SP Series Reproducer

Hundreds of broadcasters are using ITC tape cartridge equipment daily and find it delivers outstanding performance . . . such as the compact SP Series reproducer and the RP Series master recorder/reproducer shown here. And this experience has brought our attention to an interesting fact. Our tape cartridge equipment does an excellent job of selling itself. So, the problem was how to get the equipment into your studios where you could test it fully under actual broadcast conditions. The answer is our **30 day guarantee of satisfaction**. Just issue an order and we'll send the equipment you want. If for any reason it fails to perform up to your expectations, send it back within 30 days and you don't owe us a cent. It's a sure, painless, no-risk way to prove to yourself what other broadcasters already know . . . ITC tape cartridge equipment is the answer to a broadcaster's prayers. To put things in motion, call us collect at 309-828-1381.



**INTERNATIONAL TAPETRONICS CORPORATION**

2425 South Main Street • Bloomington, Illinois 61701

Marketed exclusively in Canada by McCurdy Radio Industries Ltd., Toronto

Circle 149 on Reader Service Card



Marconi showed line of television measuring instruments.



Belar had a new digital deviation and modulation monitor for AM.

Datatek's phase equalizer, waveform corrector is unit under scopes at top.





Tektronix showed new sweep system for sideband analysis of TV signal.



World Video had new portable color monitor (top), line of studio monitors.



Rohde and Schwarz demonstrated new TV waveform monitor, sideband analyzer.

Digital technique was also a main element of monitors for directional antenna arrays introduced by Potomac Instruments and Delta Electronics, the only two brands so far type-approved by the FCC under the new stricter rules on this subject, as outlined in the BM/E April issue.

For TV measurement, Tektronix came out with a new simplified Vectoroscope, the Model 1420, which displays on a CRT the vectors of chrominance and burst components of a TSC, PAL, or PAL M composite video signal.

Another introduction was that of Telemet's Model 3706A1 TV transmitter sideband analyzer. It has complete facilities for reading the frequency/dynamics of the TV signal, using crystal-controlled marker frequencies.

DataTek received considerable interest in its color phase equalizer and waveform corrector.

For a wide range of other TV test signal generators, waveform monitors, and the whole sweep of related gear, the buyer had six or seven very complete lines of high-precision instruments to choose from: CBS, Rohde and Schwarz, Marconi, Tektronix, Telemet, Philips. Rohde and Schwarz

showed, among many other units, a new TV waveform monitor, the OKF. Tektronix had their 1441 VIRS system, and 1440 automatic video corrector, premiered last year. Philips had a VITS generator analyzer duo.

There were plenty of color test generators, among them models from CBS and Telemet. Color picture monitors came from Conrac, with new models in the "universal" series with horizontal rate switchable over the range 500/60 to 1225/60, making them suitable not only for broadcast use but the high-resolution CCTV as well.

World Video showed a new portable

color monitor. Miratel showed a switched matrix monitor.

For another kind of measurement, Bird introduced their new Model 4371 digital directional rf wattmeter, which reads CW, AM, FM and SSB signals, over the range 25 to 530 MHz and from 1 watt to 1000 watts, in switchable ranges. Bird also showed their numerous other rf measuring instruments and accessories, including new rf dummy loads for 10 kw and 20 kw.

The moral seems to be that the industry is keeping up with sharpening test stringency and increasing competition,

continued on page 78

# After you use the 1056, we'll know one thing about your dub quality: it just got better.

Professional studios that make lots of dubs for radio, welcome the speed and quality they get using the Garner 1056. It offers a whole new set of advantages for producers of reel-to-reel duplicates for radio, AV, or educational needs. Some of those are: • Single capstan drives the master and all five copies. • Solid-state electronics and special heads provide outstanding frequency response. • Two-speed drive allows either 30 or 60 i.p.s. duplicating. • Extra-fast rewind of master tape speeds production. • Unique forward tilt of transport mechanism aids threading. • Conveniently located controls feature push button operation.



**GARNER ELECTRONICS**

4200 NORTH 48TH STREET  
LINCOLN, NEBRASKA 68504

Circle 150 on Reader Service Card

# Remote Control Rotary Switches

**Precision Lines for all system applications**

- Nine basic models with infinite variations
- Printed circuit and special designs
- High quality and reliability
- Positive detent action and / or momentary-contact

**Varied Range of contact arrangements**

- Low and constant resistance
- Fixed or adjustable stop
- Long life
- Quick deliveries

TEL. 201 — 944-2221  
BERGEN & EDSALL BLVD., PALISADES PARK, N.J. 07650

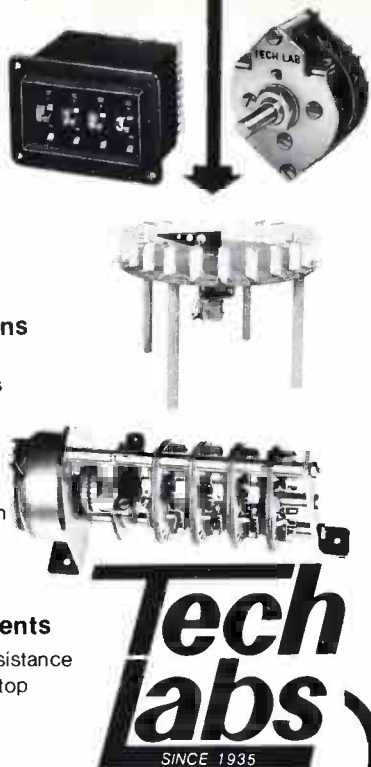

**Tech Labs**  
SINCE 1935

Circle 151 on Reader Service Card

## NAB SHOW-IN-PRINT

with more and more accurate instruments, and systems.

### Consoles: superabundance

Competitive as all major product classes were at the show, the consoles outdid all others, with 16 firms showing extensive console lines. And this superabundance is having the classic effect on quality: the console dollar is buying more than ever. Console value is also being pushed forward by advances in the art, with IC's and printed circuits, as well as new design approaches, raising performance and reliability to new highs.

Roughly, the consoles broke down into two main classes, with a few intermediates. One class is the more traditional small-to-medium broadcast board, with four to ten independent input channels, usually with switchable multiple inputs on each, rotary controls, cue and monitoring facilities, two outputs. The other is the recording style board with 16 to 30 modularized channels—each with elaborate adjustable equalization, echo input, highly flexible switching, and other

*The composite of all features most asked for in the Broadcast Industry*

# series 10 Audio Control Center

- Exceptional R.F. Shielding
- 26 Stereo Inputs
- 10 Stereo Mixing Channels
- 10 Stereo Remote Inputs
- Stereo/Mono Input Select Keys
- Digital Time Clock
- Solid State Modular Circuitry
- Conductive Plastic Stepless Faders
- Redundant Fail Safe Power Supplies
- Conjunctional Microphone Foot Switch
- Two 10 Watt Monitor Amplifiers
- Separate Program and Audition Outputs
- Separate Cue Amplifier
- Optional Equalization Controls



**Cetec** INC.  
a subsidiary of Computer Equipment Corp.

MAIN OFFICE: 13035 Salicoy St. • North Hollywood, California 91605 • Phone (213) 875-1900 • TWX: 9104992669

NASHVILLE OFFICE: Route 4 • Devens Drive • Brentwood, Tennessee 37027 • Phone (615) 794-0155

EUROPEAN OFFICE: Cetec, U.K. • Shaftesbury St. • High Wycombe, Bucks, England • Phone High Wycombe 37326 • Telex: 837329

**\$5365.00 (Professional Net)**

Circle 152 on Reader Service Card

refinements, and at least four outputs, suitable for quad.

The recording-studio class of board has been moving into broadcasting for quite some time (see *BM/E*—December, 1972), with its main market obviously among the large stations, and particularly those that do some in-house audio production work in stereo or quad. Boards built particularly for recording production studios have, of course, reached overpowering dimensions in recent years, with so many controls and so many channels, that a bomber pilot would stagger away in confusion. A trend at the show was toward modularized-

channel machines in the recording-studio style that were nevertheless somewhat limited in dimensions and aimed more particularly at broadcasting (at considerably lower cost than the biggest boards, too): a new Neve console, model 5303; the new Audio-technics Model 110; the new Cetec 29LM, some of the new Dipol SS7000 series; some new Ward-Beck models. All make excellent use of channel modularization, and have various elaborate combinations of the latest ideas in switching flexibility. For example, the Cetec has a feature called "solo," meaning any single input channel can be switched to the monitor

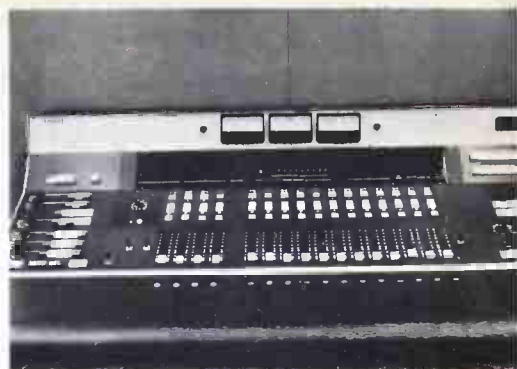

Ward-Beck showed modularized console with ten-step automatic switching.

without affecting ongoing program. Specs are sky-high, with distortion in the fractional-percent region, flat, really flat, audio spectrum response, etc.

Traditional-style boards were in greatest plenty, and their comparatively low cost and adequacy for a large class of broadcast operations are obviously maintaining a very strong market for them. The LPB S-9B (four mono channels) was probably the lowest-cost professional-grade console at the show, at \$475. Other LPB models looked like excellent values in 6, 8, 10 channels mono and stereo.

continued on page 80



Audio-technics new Model 110 console got close attention.



AM/FM stereo console was new product of CCA Electronics Corporation.

# GRANDSON

LOOK AT IT THIS WAY.

# “Grandson”

will help make an impact on your listeners and your profits using proven multi-track production techniques. We guarantee you'll love GRANDSON'S new production results and unique versatility. Where else can you find an affordable, fully modular, professional recording / production console with 54 inputs—18 mixing positions—and on-air capability?

Ask us about GRANDSON today.



**auditronics. inc.**

P.O. Box 12637 / Memphis, Tenn. 38112 / 901/276-6338

The world leader in recording consoles at sensible prices.

Circle 153 on Reader Service Card

## NAB SHOW-IN-PRINT

"Excellent value" are the right words for boards spanning approximately the same application range, from Sparta (the "Centurion" series). Spotmaster, McMartin, Gates, Ampro, Collins, CCA, McCurdy. A trend here is toward linear faders in place of rotary controls (Ampro, CCA, some Spotmasters, some Spartas), with the buyer given a choice in some cases.

Interesting new low-cost boards were Fairchild's 30000 series and Model 1632 audio mixing console, the latter especially, having highly flexible

switching, submaster mixing channels, 16 mixing channels with 64 inputs.

The lesson on consoles is clear: the most important thing is to know what you want, because whatever that is, it will almost certainly be ready for you in some maker's catalog.

### Open reels, carts, cassettes

No radically new technology turned up in the machines for recording and playing back audio on tape. But this section of the industry was no more exempt than any other from the epidemic of competitiveness, the expansion of product lines. Open-reel tape machines were on the floor from all the established suppliers of such



McCurdy Radio exhibit included new modularized console, radio line.

# MUCH MORE THAN A PRETTY FACE

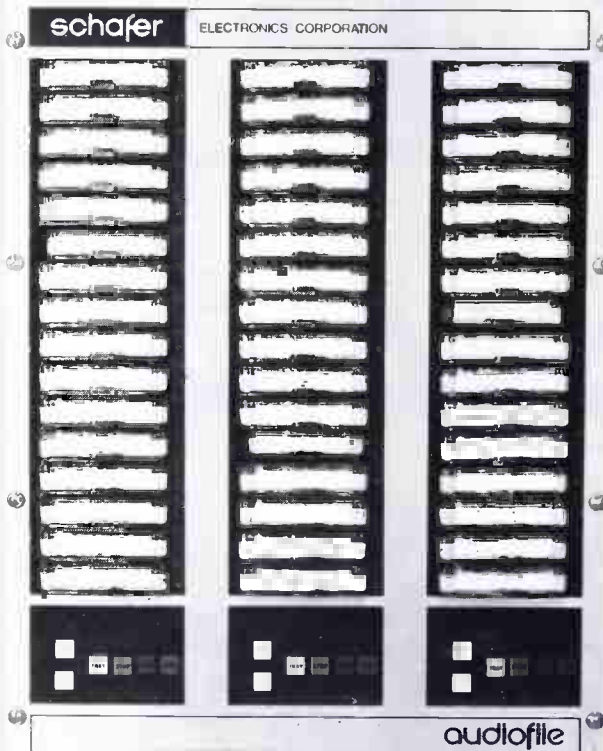

Behind this pretty face you'll find three rugged playback systems for mono or stereo cartridges that have the same quality as the most respected single-play cartridge machines in the business! Behind that, you'll find the guarantee of quality and dependability that only comes from the world's leader in automated broadcasting . . . Schafer Electronics.

# schafer

TELL ME MORE!

Name \_\_\_\_\_  
 Station \_\_\_\_\_  
 Address \_\_\_\_\_  
 City \_\_\_\_\_  
 State \_\_\_\_\_ Zip \_\_\_\_\_

Schafer Electronics Corporation  
 75 Castilian Drive, Santa Barbara Research Park  
 Goleta, California 93017 (805) 968-0755  
 Schafer Electronics Ltd.  
 5824 Burbank Road, SE, Calgary,  
 Alberta, Canada T2H1Z3

In Hawaii, Mexico, Puerto Rico  
 and the Virgin Islands contact:  
 Schafer International  
 1355 Harbor Drive  
 San Diego, California 92101

For the rest of the world contact:

**EMI** EMI Sound & Vision  
 Equipment Limited  
 252 Blythe Road, Hayes  
 Middlesex UB3 1HW England

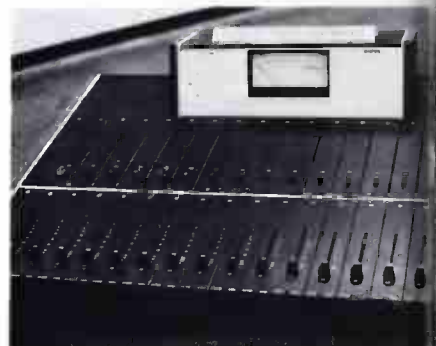

Dipol, new company, showed "table-top mixer" (above), large audio-TV boards.



Robins/Fairchild had new low-cost consoles, 5-8 channels, mono and stereo.



Sparta's "Circle of Sound" had console, turntables, cart players, all in unit.

Circle 154 on Reader Service Card



machines, with a few new ones. Operating characteristics were generally more refined, with almost every maker showing one or more design features well aimed at convenience and ease of use.

Ampex showed their new Model 40C, introduced a few weeks before the show. Electro-Sound had a new eight-track model in their ES-505 series. International Tape Tronics showed production models of their "rugged" recorder/player, in prototype last year. Other machines also especially well tailored for the broadcaster, came from Scully/Metrotech, Sparta, Telex, RCA. Ferrograph brought from England their new studio series.

Studer, now selling in this country directly, rather than through Gotham Studio, had a new moderate-priced machine, the A67, shown alongside their top-of-the-line models, seen last year. Revox, still riding their sweep of the low end of the professional price bracket with the A77, brought in a new, higher priced (about \$1800) model, the 700. United Research Laboratories, which has made a success in recent years of rebuilding sections of Ampex,

continued on page 82

## New at the N.A.B. Convention:

### The NEW 6210 Series Color Video Monitors

- 10½" rack mount
- Pulse cross
- A-B inputs
- Int-ext sync



- Back-porch clamp
- Under-scan
- All controls easily accessible

### The REVOLUTIONARY CP5002 Portable, Battery Powered, Color Video Monitor For Use With Portable Color Cameras And VTR's

- Self-contained rechargeable battery pack
- AC operation by flipping a switch



- Lightweight
- Trinitron tube
- Rugged for remote use
- Simple operation



**WORLD VIDEO, INC.**

P. O. BOX 117, BOYERTOWN, PA., 19512  
PHONE 215-367-6055

Circle 155 on Reader Service Card

# Here's Our Video Switcher



Video Switcher  
Special Effects Generator  
Model 7000

**DYNASCIENCES  
CORPORATION**

**video products**  
TOWNSHIP LINE ROAD, BLUE BELL, PA 19422  
Telephone: (215) 643-0250 • Telex: 84-6358

# Here Are A Dozen Ways To Use It

Vertical Interval Switching (8-input) • Horizontal Wipes • Vertical Wipes • Corner Wipes • Keying • Matting • Mixing • Fading • Lap Dissolve • Superimposition • Internal Black Burst • Remote Control Capability • Auto Preview Capability • Tally Switch Capability • Sync Adding Capability • No drive pulses required • plus it is a 3-buss unit which accepts 8 synchronous inputs and 5 non-synchronous inputs • For further information, contact: Dynasciences Video Products.

Circle 156 on Reader Service Card

# What A Figure...

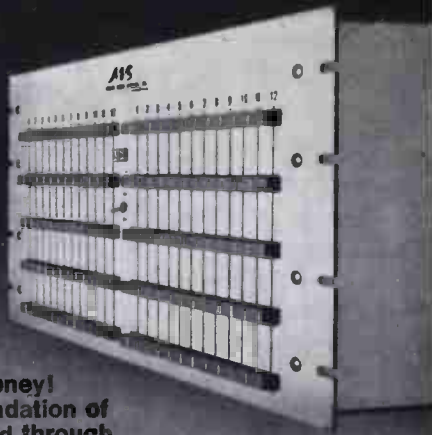

Marco Video Series RS Routing Switchers give you the best signal-to-noise figure for your money! 69 dB S/N assures minimal degradation of video-audio quality even when fed through the switcher many times. Add in:

- Hand-trimmed Differential Gain and Phase to meet and exceed the most stringent tolerances.
- Compact size to reduce rack space requirements.
- Configurations from 12 X 6 through 12 X 200.
- Low Price

Call DeWitt Smith today for details.

**MARCO VIDEO SYSTEMS, INC.**

6114 N. 20th Street, Philadelphia, Pa. 19138 • 215 VI 9-9500

Distributor and Rep Inquiries invited.

Circle 157 on Reader Service Card

## TIMELY—AND DIGITALLY!

A timer for all time, on-air and production.

Here's a digital stopwatch with large numbers, large easy to use pushbuttons—and a small price. A small price for high accuracy. Was that commercial 59.1 seconds or 59.9 seconds? Now you can easily see the time to a tenth of a second on the large Sperry readouts.

Effective RFI shielding design keeps the timer accurately counting in severe RF fields.

Remote control—all functions available through the rear panel connector. An optional remote control box is available for your special applications.

If you need to check specific times while running down a production show, you merely punch the display hold button, note the time, and release. The Digitimer will catch up to the running time, immediately.

Our Digitimer is available for you—immediately. We keep the time, you keep the audience.



PACIFIC RECORDERS AND ENGINEERING CORPORATION  
11760 SORRENTO VALLEY ROAD, SAN DIEGO, CALIFORNIA 92121  
TELEPHONE (714) 453-3255 TELEX 695008

Circle 158 on Reader Service Card

## NAB SHOW-IN-PRINT

RCA, and other leading makers, showed its own complete tape machines.

Machines for recording on and playing back audio carts (standing alone, outside of automation systems) also came from all the firms in this line in recent years, including Tapecaster, Broadcast Electronics (Spotmaster), International TapeTronics, Sparta.

Gates introduced a compact three-unit cart player, the Criterion Compact-III, with the players mounted vertically. Two Compact-III's will go side-by-side in a standard rack, to provide six independent play units in a small space. Each has a direct drive synchronous capstan motor, plug-in cue and program amplifier cards, silicon transistors and IC's. Adding it up, the broadcaster has a wide choice of good cart equipment.

However, one section of audio tape technology, the cassette, still seems to be in the semi-limbo for broadcasting it has occupied for several years. For anything to happen in cassettes of substantial interest to broadcasters, a number of firms would have to apply themselves to the job of getting cassette technology up to broadcast standards. The reasons for attempting this are obvious—the mechanical advantages of reel-to-reel cassette as against the endless loop cart, the cassette's smaller size, etc. The reasons for *not* doing it are also obvious—the big quality ad-



New cart players from Ampro can be installed 3 in a line across rack.

Studer introduced new medium-price open-reel tape machine, the A67.



# BULLETIN!!

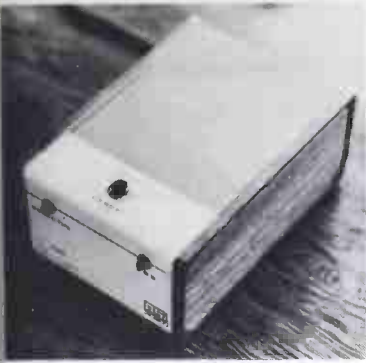

The ASI Tel-alert was a hit at NAB in Houston! For those of you who saw Tel-alert and especially the many who bought one, we say thank you. For those of you who didn't get to the convention this year, here's what you missed:

Tel-alert is the first all solid state method for remote indication of news wire Bulletin or EBS transmissions. Instead of noisy steppers and relays, Tel-alert utilizes digital integrated circuits. And because of this all solid state design, Tel-alert is both quiet and compact allowing it to fit in anywhere — even right on top of the console close to live mikes.

Remember, the newly revised part 73.961 of the FCC Rules and Regulations requires all stations to log the now bi-monthly news wire EBS Test Transmissions. So if your station is missing these tests because your news wire machine is out of the sight and hearing of your air people, you need Tel-alert. If your competition is scooping you because Bulletins go unnoticed, you need Tel-alert too.

Just circle the number below and we'll send you complete specifications. But hurry, while our NAB Convention prices are still in effect! They start at just \$65 for the basic system, so you really can't afford to be without Tel-alert. We'll also send you information about the many ways ASI's custom Equipment and Turn-key Installation Divisions can help make a great station like yours even greater. After all we're . . .

THE INNOVATORS  
AT



2101 GRATIOT AVENUE  
DETROIT, MICHIGAN 48207  
(313) 963-6538

Circle 159 on Reader Service Card

## NAB SHOW-IN-PRINT



Rapid-Q's new broadcast cassette system had 9 players in a 3 x 3 assembly.

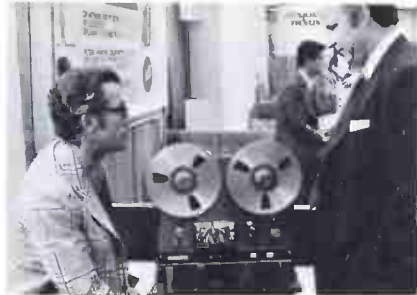

International Tapetronics had production model of new open-reel machine.



Gates introduced compact 3-player cart unit, 8 1/2 inches wide.

vantage of the larger tape and higher speed of the cart. Evidently the cons have seemed stronger than the pros to most potential makers so far.

Rapid-Q showed some new cassette recording and playing equipment with specifications that could meet a broadcaster's needs. Included were the CA74P3, a three-unit playback assembly, and the companion recorder/player, the CA74RP. These units operate at either 1 1/2 or 3 3/4 ips, and at the higher speed claim flutter, signal/noise, distortion and response specs, that look fully acceptable for broadcast use.

Paul Schafer, now working independently of the firm he founded, Schafer Electronics, has also been attacking the cassette technology intensively, and also showed recording and playback units aimed at broadcast use, to be made and sold by Control Design Corp., in "about 120 days." He prom-

continued on page 84

# CAN YOU MATCH THIS NEW TVP P-20 PEDESTAL?

PNEUMATIC-BALANCE CAMERA PEDESTAL WITH 20" VERTICAL TRAVEL FROM A LOW OF 30 3/8" TO A HIGH OF 50 3/8"

- 15 to 200 lb. capacity — takes large camera or compacts.

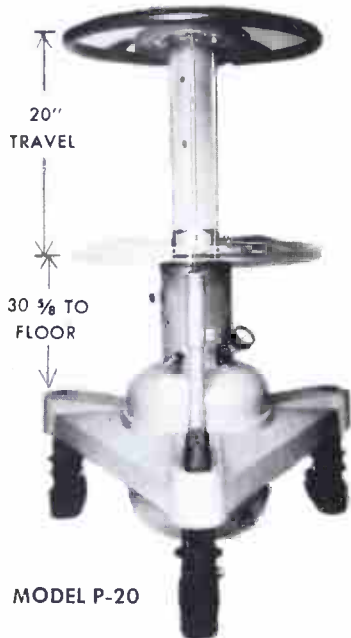

MODEL P-20

- 4 1/2" camera column balanced pneumatically, with floating action — no weights or crank.
- Vernier control drag/brake on camera column
- Vertical motion controlled by steering wheel — raises or lowers with camera. Will glide through 32" doorways.
- Crab and tricycle steering with foot pedal mode selector
- 8" Resilient tired, ball bearing wheels offer easy, smooth roll
- Fully adjustable cable guards
- Weighs only 150 lbs. — Raised Base For Easy Portability
- Minimum maintenance requirements.
- Provides the same dependability, simplicity, versatility that has characterized our larger units through ten years in the three major networks without overhaul.

Made in U.S.A.

Priced under \$1700.00

Pedestals since 1952

Write or phone for complete data

Phone (213) 776-3276

Television Products Co., Inc.

9016 AVIATION BLVD., INGLEWOOD, CA 90301

Eastern Area:

Listec Television Equipment Corp.

35 Cain Drive

Plainview, New York 11803

Phone: (516) 694-8963

Circle 160 on Reader Service Card

# Quality and economy can go together... we did it with Encore tape cartridge equipment



Encore Reproducer \$475

Some broadcasters want and need an economy line of tape cartridge equipment. We incorporated the best features of our premium line into Encore. We simplified systems, circuits and manufacturing techniques. And we created further economies by selling direct, with payment due when you order. We offer a 30-day guarantee of satisfaction plus a one year warranty. Call us collect today and find out why many broadcasters are finding quality and economy under the Encore name.

Encore Recorder/Reproducer \$630



Call 309-828-1381 collect for details on the Encore series



INTERNATIONAL TAPETRONICS CORPORATION  
2425 South Main Street,  
Bloomington, Illinois 61701

Circle 161 on Reader Service Card

## NAB SHOW-IN-PRINT



Elpa introduced the Ferrograph Studio 8 open reel machine.



Broadcast Electronics had cart players, consoles, turntables, automation units.

used a 50-unit carousel-type cassette machine "before too long."

As has been clear for a number of years, only moderate advances in the art, including advances in the tape itself, are needed to make the cassette a broadcaster's tool and a very handy one.

Rapid-Q was also showing expanded equipment lines for its Cartette, the "mini-cassette" the firm introduced a couple of years ago, for voice-quality, low-cost tape applications.

**Microphones, turntables, pickups, etc.**

It is essential stuff and it was there in plenty, though without large-scale technical ferment—the audio gear beyond the consoles and tape machines already covered.

A new idea in condenser microphones—modular systems expandable to any application need—was introduced by Studer, a company itself new to the show because of a recent move to direct marketing in this country (see the note on this in the tape machine coverage, above).

Shure introduced a brand-new microphone, the SM7, a cardioid dynamic aimed at the top professional jobs, with switch-selectable frequency response tailoring. AKG had on hand their very complete line, and Revox showed the Beyer mike line. RCA had their microphones; Gotham audio showed the Neumann mikes.

In turntables, one new note was the

## AUDIO DISTRIBUTION AMPLIFIER SYSTEM



- Selection of 12 Unbalanced or 6 Balanced Transformerless Outputs per Input
- Extensive Headroom; +24dBm Balanced, +27dBm Peak, +18dBm Unbalanced
- Flexibility with 10dB Gain Adjustment for Each Balanced Output, Front Panel Controls
- Unsurpassed Output Isolation, 80dB Between Outputs @ 20Hz-20kHz
- Exclusive LED Output Overload Indicators, 12 per Module
- Transformer Coupled Input to Avoid Ground Loops
- Modular Construction with Plug-In Amplifiers
- Input Matches or Bridges 150 or 600 ohm Lines
- Microphone Input With Up To 50dB Switchable Attenuation

All of these reasons and more, plus careful thermal engineering and a hefty power supply, are why DA-126 is the leading choice for a dependable, high quality audio distribution amplifier.



13035 Saticoy St. N. Hollywood, Calif. 91605  
Phone: (213) 875-1900 TWX: 9104992669

Circle 162 on Reader Service Card

MICRO-TRAK MICRO-TRAK MICRO-TRAK MICRO-TRAK

**THE PACKAGE**

740                      303

6401

... TRY IT

**MICRO-TRAK**  
FORMERLY GRAY RESEARCH

HOLYOKE, MASSACHUSETTS 01040  
MICRO-TRAK MICRO-TRAK MICRO-TRAK MICRO-TRAK

Circle 163 on Reader Service Card

## LAB SHOW-IN-PRINT



Burwen demonstrated new dynamic speech filter for cutting remote noise.

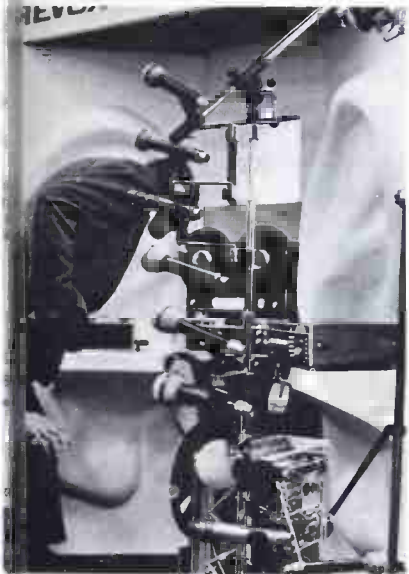

Revox microphones were assembled on stand at Revox exhibit.

CCA-QRK "Alpha," an "instant-  
" machine aimed at cutting cue  
e, available with electronic speed  
control. CCA-QRK was also offering  
electronic speed control in a sepa-  
unit, usable with any turntable  
covered by a synchronous motor.  
ntables were also on display from  
er makers well-established in this  
a: Microtrak, Gates, RCA, Gotham  
h EMT tables).

Microtrak showed their whole line,  
roduced at earlier shows, including,  
ides the turntables, tone arms,  
amplifiers, one- and two-table con-  
ps, monitor speakers. CCA-QRK's  
line was there too: tone arms, con-  
s, preamps. Shure had their new  
30 gated compression mixer, which  
automatic gain riding with a  
emory" that bridges pauses to  
imize noise build-up. Brand-new  
was the M625 "Voicegate," a  
er for remote mike applications  
h an automatic voice-operated  
quency-shapping circuit that nar-

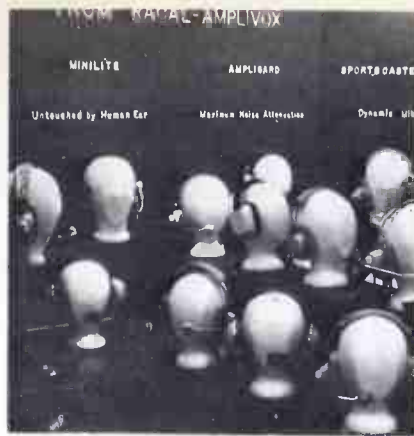

Line of Racal-Amplivox headphones were shown by Television Equipment Assoc.



Microtrak had complete line of turntables, arms, preamps, speakers.



Gotham Audio stressed EMT turntables, reverb unit, audio compressor.

rows to cut noises in the pauses, and is designed to distinguish between voice and noise, to let the voice through.

Shure also showed their well known line of phono pickups, introducing a new model, the SC35C, which is a heavy-duty design for rugged broadcast use. Familiar pickups also were on hand from Stanton, who added to their established series their new designs for CD-4 "discrete" quad service.

Audio Devices had two new products: a high-output, low-noise (HOLN) mastering tape and a new NAB-spec broadcast cartridge, the Audiopak A-2. The latter claims improved braking for holding the cue, and new guidance design for minimizing skew and edge wear.

In another vital area, audio noise reduction, Burwen Laboratories introduced the Dynamic Speech Filter, intended specifically for improving the quality of remote pickups arriving by telco lines. Using the dynamic fre-

continued on page 86

# Broadcasters!

Here is an important new device designed especially for you.



## Timekeeper Telephone Line Equalizer

How would you like a compact, self-powered telephone line equalizer for use in radio, TV or communications systems that helps restore signals lost in long transmission lines? One that could be adjusted to suit a variety of conditions—one that can easily be inserted into any existing system and which would provide additional gain when necessary? An equalizer that could have balanced input and output to assure complete line isolation?

The TIMEKEEPER MODEL TLE-1 is just such a unit. Using the latest OP AMP active filter design it provides excellent stability, low distortion and low noise. The extremes of the audio spectrum are purposely rolled off to reduce any further unwanted noise.

### USES

Radio talk shows, remote pickups using telephone lines, even stations using their own lines will find this unit essential. Not only can it be used at the receiving end—it can also be quite useful at the sending end. If you know what losses to expect from the line you can pre-equalize the signal to improve response with less noise!

The TLE-1 is built to the highest standards in the industry and is unconditionally guaranteed for one year. If you find it does not improve your signal—return it for a full refund. You will find the TLE-1 a great buy at only \$295.00.

It's a TIMEKEEPER product.  
It's got to be good.

### Telephone Line Equalizer Model TLE-1 PERFORMANCE SPECIFICATIONS

Gain, variable	unity—20db
Input impedance	600 ohms
Output impedance	20 ohms (designed to work into 150 or 600 Ohm loads)
Max. input level	+20 dbm (at unity gain)
Max. output level	+20 dbm
Frequency response	± 1/2 db 50-15,000 Hz
Available boost (cont. controlled)	20 db max at the extremes of covered spectrum
Distortion	less than 0.2%
Noise	70 db below 0 db level
Isolation	transformer, balanced floating line
Power required	117VAC @ 1 watt
Dimensions	panel: 1 3/4" wide x 7" long chassis and transformers: 6 1/2" deep, 6" wide x 1 3/4" thick 1.5 lbs. mounting rack available
Terminations	Barrier strip, screw terminals
Amplifiers	IC OP amps, plug-in
Controls	ON-OFF switch Gain control Low end boost High end boost LED pilot light
Indicators	

Send check to

### TIMEKEEPER

Box 35 Great Neck, N.Y. 11021

Please send me \_\_\_\_\_ Model TLE-1 Telephone Line Equalizer(s) at \$295.00. N.Y.S. residents add 7% sales Tax. I enclose \$ \_\_\_\_\_

Name \_\_\_\_\_

Address \_\_\_\_\_

City \_\_\_\_\_

State \_\_\_\_\_ Zip \_\_\_\_\_

Circle 164 on Reader Service Card

# LISTEC REMOTE PEDESTALS GO TO YOUR HEAD



Here are two new TV Camera Pedestals\* that will end traditional tripod problems forever. What tripod can set up in less than a minute, be sturdy enough for up to 250 lb. loads, and even cost less than your present tripod?

These new remote, lightweight pedestals do! Take them anywhere. Set the common folding skid down, put in the interchangeable center unit in one easy push-lock motion and you're ready to mount the head. Isn't it time you looked into how Listec remote TV camera pedestals can go to your head?



**Model 730** Geared, elevator pedestal/dolly combination complete with cable guards. Provides 24" cranked lift of load on sturdy column with separate folding dolly featuring 10" diameter wheels for both castoring and straight-line tracking. Units together weigh 90 lbs. Capacity load is 200 lbs. \$1245.

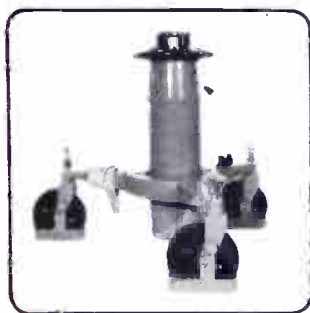

**Model 729** Air counterbalanced pedestal/dolly combination complete with cable guards. Provides 22" counterbalanced lift of load on sturdy column with separate folding dolly featuring 10" diameter wheels for both castoring and straight-line tracking. Units together weigh 105 lbs. Capacity load is 250 lbs. \$1990.

\*Manufactured for Listec by Vinten, Ltd.

Write for information today

See us at the NAB Show Booth 906 West Hall

**Listec Television Equipment Corp.**  
35 Cain Drive, Plainview, New York 11803  
516-694-8963

Circle 115 on Reader Service Card

## NAB SHOW-IN-PRINT

quency response technique of the larger Model 1000 (Dynamic Noise Filter), but with constants more appropriate to getting decent voice material out of the air from remotes, the Speech Filter is priced at \$700, against the \$3550 for a two-channel version of the wide band, "high fidelity" Model 1000.

A company at the NAB for the first time, Audio Services, Inc., of Detroit showed some examples of equipment and design developed for their customer audio installations, which include complete studios and audio lines for broadcast stations. They also had for product: the "Tel-Alert," an automatic solid-state alarm which reads five-be signals on a news wire and can ring bell, light a light, or otherwise alert news personnel.

Fidelipac showed their long standard line of audio carts, and two new products: an "On Air" light for studios, and a rack series for storing carts.

Exhibitors prominently displaying headphones included Stanton, Revco (the Beyer line), Telex, and Racal (the Television Equipment Association Booth).

### For more information on selected new products at NAB 1974:

IVC-9000 VTR	350	3M MT 2250 video tape	3
Ampex AVR-2 VTR	351	Berkey Colortran lighting	3
RCA TR70C VTR	352	memory center	3
TMI 600 series TBCs	353	Gates RA 10/SS controller	3
Ampex TBC 800	354	Schafer 903 with 7-day	3
3M DP-100 TBC	355	memorv	3
IVC model 2000 TBC	356	Schafer Autofile/Autocue.	3
CVS video synchronizer	357	Control Design CD 28	3
TeleMation frame		programmer	3
synchronizer	358	Control Design carousel	3
Philips PCP-70B mini		CD24R	3
camera	359	CDL APC 600/100 TV	3
TCA TKP-45 mini camera	360	automation	3
Marconi Mark VIII mini		McMartin BA-1K transmitter	3
camera	361	Gates MW-5-AM transmitter	3
Editel ENC-1 mini camera	362	Sintronic series	3
Shibaden NHL system	363	Jampro circularly polarized	3
Commercial Electric (mini		TV antenna	3
camera	364	McMartin peak modulation	3
Ikegama mini camera	365	monitor	3
IVC-7000 studio camera	366	Belar peak modulation	3
Vital VIX 114 production		monitor	3
switcher	367	Telemet sideband analyzer	3
TeleMation TVS-1000 dist.		3706A-1	3
switcher	368	Cetec 292M console	3
American Data 900 series		Auditronics Model 110	3
dist. switcher	369	console	3
CBS digital sync encoder	370	LPB S-9B console	3
TeleMation sync generator		Fairchild 3000 series console	3
TSG 525	371	Ampex 440C tape recorder	3
Cooke Engineering program		Electro Sound ES-505-8	3
timer	372	tape recorder	3
Chiron Mark III character		Studer A67 tape recorder	3
generator	373	Revox A700 tape recorder	3
RCA Video Four character		Gates compact III, cart	3
generator	374	player	3
Datavision 3000 character		Rapid Q cassette player	3
generator	375	Shure SM7 microphone	3
CMX-50 video tape editor	376	CCa QRK "alpha" turntable	3
Memorex Grade H video		Burwen dynamic speech	3
tape	377	filter	3

BN

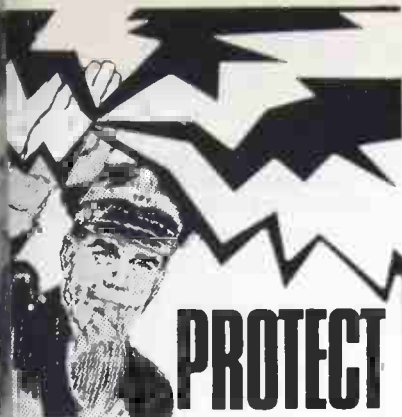

# PROTECT your broadcast equipment against lightning surges with WILKINSON AC LINE SURGE PROTECTORS

Excessive voltage surges caused by lightning, transformer arcing and induced transients are everyday occurrences that cause heavy damage to valuable broadcast equipment.

Now through the use of WILKINSON voltage sensitive Line Surge Protectors you can protect your equipment from line surges that may exceed even twenty times the normal line voltage.

A WILKINSON pulse compensated Line Surge Protector, is placed across a line of its rated voltage. Should a surge or increase of voltage occur, the resistance of the varistor decreases logarithmically as the voltage increases, thus acting as a momentary load or short circuit to the line. WILKINSON Line Surge Protectors draw little or no current and are capacitor compensated for microsecond surges, thus damping line disturbances as well as excessive voltage increase.

A small investment in WILKINSON Line Surge Protectors is your assurance that your valuable broadcast equipment will not be damaged by line surges.

- Model SIA-1 110 V. Single phase \$175.00
- Model SIA-2 220 V. Single phase \$275.00
- Model SIA-3 220 V. Three phase \$375.00
- Model SIA-4 440 V. Three phase \$475.00

For complete details write to:

## WILKINSON ELECTRONICS, INC.

7 MacDADE BLVD. • WOODLYN, PA. 19094  
• TELEPHONE (215) 874-5236 874-5237

Circle 166 on Reader Service Card

## NEW LIT

For copies of these literature offerings, circle number for appropriate items on Reader Service Card.

**“How to Improve Your TV and FM Reception”** is a new 16-page illustrated booklet that explains in simple language reasons and corrections for common reception problems. Cost is 25¢. Channel Master Division of Avnet, Inc., Ellenville, NY 12428.

Complete catalogs of Bowmar spec sheets are now available. Copies of catalogs as well as three-ring organizers, **Communications Test Equipment**, including product literature, are available—on letterhead only—to James Bender, Marketing manager, Bowmar Instrument Division, 531 Main St., Acton, MA 01720.

**“The Executive’s Guide to Closed Circuit Television”** describes types of CCTV systems, equipment needed and actual installation. Also discusses their use in producing videotapes for training and educational programs. GBC Closed Circuit TV Corp. **250**

**Data sheet describes new low frequency spectrum analyzer.** Tektronix. **251**

**New Model M-3 Optical Multiplexer** is detailed in Data Sheet 6-611. Cohu. **252**

**New, two-color data sheet describes Tympani line of loudspeakers**, including specifications on performance and on physical factors. Audio Research Corp. **253**

**On The Air** is a new quarterly newsletter concerning new developments in the

## CARTRIDGE TAPE EQUIPMENT

- Compact Modules
- Multiple Units
- Single Units
- Record/Playback
- Playback Only
- Monaural
- Stereo

INFORMATION  
ON REQUEST



GARRON ELECTRONICS INC. TM  
**RAPID-Q**



1216 KIFER ROAD SUNNYVALE, CALIF. 94086 (408) 736-8737

**THE BLOCKS TO BUILD ON! RAPID-Q!**

Circle 167 on Reader Service Card

broadcast industry. Also concerns company’s products and how they affect TV operations. Acrodyne Industries. **254**

**Description and specifications of portable, minaturized environmental cameras** are provided in new data sheet 6-591. Cohu. **255**

**New 4-page, 2-color brochure covers direct coupled and baseline servoed log video amplifiers and RF log detectors.** American Astrionics Division of Technicolor, Inc. **256**

**New full-color booklet details features and specs of 170 Series color video tape** for one-inch helical scan recorders. Tape is first high-energy

## “FIVE” MIXER AUDIO CONTROL

**B-500 series** the new leader in audio console design—a plug-in modular system lets YOU choose your inputs—models for every operating mode... monaural, stereo and dual channel

# consoles



**McMartin**

McMartin Industries Inc., 4500 South Seventy-sixth Street Omaha, Nebraska 68127 Phone (402) 331-2000

Circle 168 on Reader Service Card

## NEW LIT

type video tape to use a standard ferric oxide formulation. Ampex. **257**

Test data from independent labs confirming RFI integrity of Electro-Mechanical Division of EG&G's standard CATV Connector Line is provided in RFI Test Report. EG&G. **258**

New data sheet describes compact production video switcher that is contained in less than one cubic foot of

space, and provides for mixing that holds sync constant through the fade. Cohu. **259**

New telecommunications catalog describes over 60 products in line of video, voice and data transmission systems, including technical data pictures, and reference sources. GTE Lenkurt Inc. **260**

Data is available on new gallium arsenide stacked diode laser, the SG3001, designed for pulsed operation at room temperature; and two gallium laser array modules, the C30020 and the C30021, intended for pulsed operation at cryogenic temperatures.

RCA

New data sheet describes 1200 Series of single tube color TV cameras for use in studios, film chains, and environmental applications. Data Sheet 6-559. Cohu. **262**

"Microwave Counters: Manual or Automatic? Heterodyne or Transfer Oscillator" is new 16-page application note. EIP. **263**

The 1974 Revised Edition of the Media Awards Handbook is now available. Cost is \$15. Write to: Media Awards Handbook, 621 Sheri Lane Danville, CA 94526.

## PRICES SLASHED DELIVERY 4 TO 6 WEEKS

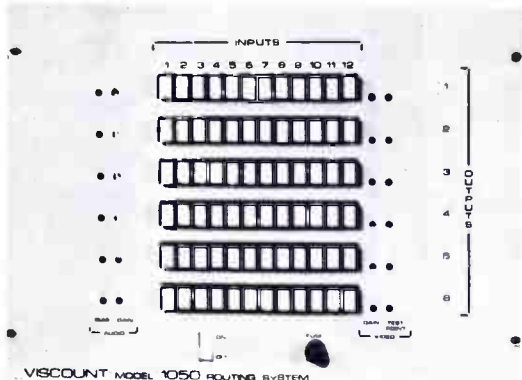

**MODEL 1050 ROUTING SYSTEM**  
THE MOST RELIABLE, LOW-COST  
SWITCHING MODULE YET

FACTORY ASSEMBLED		PRICE EXAMPLES		
INPUT	OUTPUT	VIDEO	AUDIO	AUDIO/VIDEO
12	X 3	\$ 1200	\$ 860	\$ 1490
12	X 6	1710	1370	2150
12	X 9	2380	1980	3000
12	X 12	2920	2520	3720

**VISCOUNT INDUSTRIES LTD.**

105 EAST 69th AVE.,  
VANCOUVER 15, B.C.

TELEPHONE: (604) 327-9446

Circle 169 on Reader Service Card

## Do-It-Yourself Console

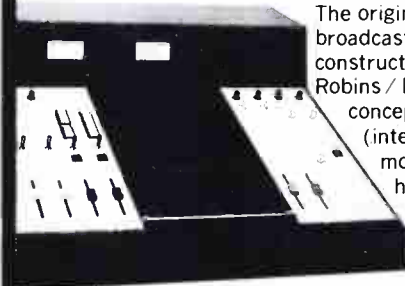

The original modular approach to broadcast console design and construction using the unique Robins/Fairchild building block concept. With the ICBM (integrated circuit broadcast modular system) you can have complete broadcast consoles with only seven different plug-in modules.

Each compact "packaged" module is a complete operating channel. The modules plug-in (and out) as simply as a household plug.

With these unique plug-in units a broadcast studio can be started with a few channels and gradually expanded or channels can be moved from one studio to another as programming requires.

FOR COMPLETE DETAILS CALL OR WRITE RICK BELMONT.

**ROBINS & FAIRCHILD**

A Robins Industries Corporation

75 Austin Boulevard, Commack, N.Y. 11725  
(516) 543-5200

Circle 170 on Reader Service Card

Looking for a taperecorder?

At the NAB Most automation systems used REVOX — so

**It Has To Be Good**

For the BEST value in taperecorders its

**REVOX**

For the Best Buy in broadcast equipment its



**Val-Tronics, Inc.** Box 666, Avoca, Pa. 18641 717-457-8816

Circle 171 on Reader Service Card



## GREAT IDEAS

### 33. Voice Coupler Auto Answerer.

Donald Rees II, V.P. Chief Op.,  
WAMX-FM, Ashland, Ky.

**Problem:** To prevent telco dropout while using a voice coupler for remote broadcasts. When the connection is broken, it often is not possible to restore it unless the remote crew takes equipment off the line, or until a phone company operator restores the connection. Besides taking time, it can cause havoc if the line is lost in the middle of a burn-in.

**Solution:** Our device automatically answers the voice coupler line at the remote site and connects the remote equipment to the line. Should the line

drop out during the broadcast, it will automatically disconnect. Then the station engineer, oftentimes a technically inexperienced disc jockey, redials the voice coupler number and the remote unit will reset everything.

A low-power AC relay and capacitor detects the ringing voltage on the line and energizes DC relay K2. It pulls in and answers the circuit. Current flow through the coil resistance is sufficient to allow the relay to hold the line until the circuit is broken by either the calling party, or circuit failure. Neon lamp NE2 flashes whenever the unit answers a call and gives the remote crew a visual indication someone has called. It also acts as the ring voltage load as NE2 fires.

The repeat coil is type IIIc.

Note that the circuit must be used on a local exchange loop. It may not work on some telco carrier circuits.

### 34. Date-Code Films & Tapes With Colored Tape.

William Gramling, Engineer, WRC,  
Washington, D.C.

**Problem:** To store commercial films and tapes accumulating at the station. It is often difficult to decide which are the current, and which are obsolete tapes in the library.

**Solution:** Obtain several rolls of colored tape. Place a small tab of one color on each commercial box. When the tapes are pulled for the day's use, remove the tab. After several weeks, the obsolete tapes (the ones with the tabs still on them) are discarded. Colored tape tabs are now placed on video carts, rotating different colors on a regular basis to indicate which are still in use.

### 35. O.K. the Day's Programming With Rubber-Stamp Checklist.

Howard L. Enstrom, General Manager,  
KBY, Billings, Montana

**Problem:** To enable management to check each day's programming with regard paid to FCC requirements.

continued on page 89

Circuit for automatically answering voice coupler line  
1—is P&B Model KPH  
7A17  
2—is KB H17D12

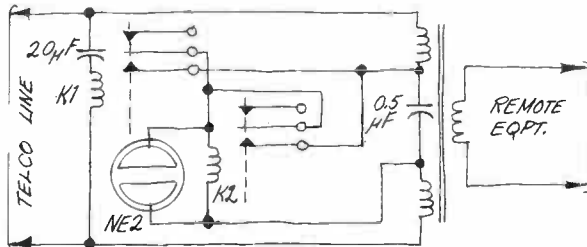

## Series 20LM Live Media Console



- Available with up to 32 Inputs and 10 Outputs.
- Programmable Mute allowing up to four different "scenes" to be setup simultaneously on the console.
- Total Modular construction.
- Four Group Submasters.
- Three Knob Equalizer per input channel.
- 4 Mic or Line Remotes per Input module.
- Two Foldback/Cue Buses with Pre/Post Fader Selector.
- Stereo Pan Pot with IN/OUT Key per Input Channel.

- Line/Mic Switch with 0-20-40-60 dB of Attenuation.
- Echo Send and Receive controls.
- Phase Switch on each Input.
- Available in Portable carrying case.

Plus many other features usually found only at much higher prices. Combine these with the traditional Cetec quality and service, and you have the Series 20 LM, Live Media Console.

**Cetec**  
INC  
a subsidiary of Computer Equipment Corp.

13035 Saticoy St., North Hollywood, Calif. 91605  
Phone: (213) 875-1900 TWX: 9104992669

EUROPEAN OFFICE Cetec U. K.  
Shaftesbury Street, High Wycombe, Bucks, England  
Phone: High Wycombe 37326 Telex: 837329

Circle 172 on Reader Service Card

**Solution:** Make up a rubber stamp giving a breakdown of the day's programming as entered in the log. The impression of the stamp is made at our station on the back side of the last page of the daily program log. Each morning the Traffic Manager enters the previous day's program by class time. The number of minutes is entered in the proper block, divided by the total number of minutes of the broadcast day with the percentages also entered. If each day's percentages fulfill the station's commitment to the FCC, obviously, any composite week will also meet such a requirement.

could be eliminated by further troubleshooting.

**Solution:** When a distortion or noise measurement is made, you can hear exactly what is going on before believing the meter reading. For example, the distortion meter may read 10%, but an

aural check of the signal at the analyzer's output terminals shows a strong hum signal; you have just determined that what looked at first like high distortion was hum, perhaps from a ground loop in the measurement equipment. **BM/E**

### 36. How to more accurately interpret Harmonic Distortion Measurements.

Mark J. Wharton, Chief of Radio Technical Operations, AFRTS, Los Angeles, Ca.

**Problem:** To more accurately interpret harmonic distortion measurements. Most harmonic distortion analyzers have output terminals that contain the signal fed to the metering circuit. Instead of just looking at a meter, listen to the amplified noise and see if it contains any hum or buzz that

Rank each idea on a 0 to 10 scale on the form below, or write your ranking on the Reader Service Card in the back of the magazine in the space "Tell us what you like..."

#### Great Idea Contest

BM/E  
274 Madison Avenue  
New York, N.Y. 10016

Here's my ranking on a 0 to 10 scale of the May Great Ideas.

- |   |   |   |
|---|---|---|
| 27. Hinged patch panel                      | [ | ] |
| 28. Auto-reset overload                     | [ | ] |
| 29. EOT stimulator for cart machine         | [ | ] |
| 30. Telephone operation on talk shows       | [ | ] |
| 31. Off-air pickup for network TV           | [ | ] |
| 32. Transferring news to cart machine       | [ | ] |
| 33. Voice coupler auto answerer             | [ | ] |
| 34. Date-code films                         | [ | ] |
| 35. O.K. days programming with rubber stamp | [ | ] |
| 36. Interpreting harmonic distortion        | [ | ] |

Name \_\_\_\_\_ Title \_\_\_\_\_

Station or Company \_\_\_\_\_

**Enter Your Own Great Idea Now. You May Win a Windjammer Cruise. See Contest Rules.**

## A LIMITER WITH INSTANTANEOUS ATTACK--LESS THAN 1% DISTORTION



WILKINSON ELECTRONICS LA2-C/S  
STEREO OR MONO

- \* Distortion — ¼% for 6db of limiting. 1% or less to 20db of limiting.
- \* Attack Time — 5/4 Radlans for gain control before clipping.
- \* Overlimit Attack Time — Instantaneous.
- \* Compression Ratio — More than 35:1.
- \* Frequency Response — + 1db 50Hz to 35KHz with full limiting.

For complete details write:

**WILKINSON**  
ELECTRONICS, INC.

1937 MacDADE BLVD.  
WOODLYN, PA. 19094  
PHONE (215) 874-5236 874-5237

Circle 173 on Reader Service Card

## A NOISE FREE AGC AMPLIFIER WITH A DYNAMIC RANGE PRESERVER



WILKINSON ELECTRONICS GCA-1  
STEREO OR MONO

- \* Noise — -75db even with loss of input. Automatically "rides" gain without regard to peaks. Exclusive RMS Detector preserves dynamic range. Will not adjust gain if signal removed.
- \* Distortion — 0.1% all gain settings.
- \* Frequency Response — ± ¼db 50HZ to 20KHz any gain setting.

For complete details write:

**WILKINSON**  
ELECTRONICS, INC.

1937 MacDADE BLVD.  
WOODLYN, PA. 19094  
PHONE (215) 874-5236 874-5237

Circle 174 on Reader Service Card

# BM/E CLASSIFIED MARKETPLACE

## CLASSIFIED ADVERTISING RATES

DISPLAY CLASSIFIED ADVERTISING: \$32.50 per inch 1x; \$30.00 per inch 6x; \$27.50 per inch 12x. ALL OTHER CLASSIFIED ADVERTISING 35¢ per word; minimum \$3.50. BLIND BOX NUMBER: \$1.00 extra charge. Replies sent to address below will be forwarded to you. PAYABLE IN ADVANCE; send check with order. CLOSING DATE: 5th of 2nd month preceding issue date.

BM/E, Monterey and Pinola Avenues, Blue Ridge Summit, Pa. 17214 Phone 717/794/2191

### HELP WANTED

#### ASSISTANT CHIEF ENGINEER

Assistant Chief Engineer wanted for TV Station in Top Ten market. Must hold valid First Class Radiotelephone License and have at least 5 years broadcasting experience. Also need proof of performance experience and studio and transmitter maintenance experience. Prefer applicant with E.E. degree and P.E. Salary open. Send resume to Box 574-2, c/o BM/E Magazine, Blue Ridge Summit, PA. 17214. An Equal Opportunity Employer.

Radio-TV Engineer I—High School diploma and two years experience in the operation and maintenance of a variety radio and television equipment. First Class FCC License preferred but not required. Salary range \$7600-\$10,315. Interested persons should contact the University of South Florida, Personnel Services, Tampa, FLA. 33620. The University of South Florida is an Affirmative Action Equal Opportunity Employer.

Chief Engineer—Excellent Opportunity for Chief Engineer in Midsouth. Require knowledge of directional A, UHF transmitters, and RCA studio equipment. Must be experienced in supervision, maintenance and annual pops. Very good salary with excellent equipment and working conditions. Send resume, references and salary requirements. Reply to Box 574-1, c/o BME, Blue Ridge Summit, PA. 17214.

Large midwestern communications company requires an experienced video engineer to manage service, installation and Systems Engineering departments. Excellent salary and fringe benefits. Reply to Box 574-3, c/o BM/E Magazine, Blue Ridge Summit, PA. 17214.

### EQUIPMENT FOR SALE

FOR SALE: CATV Local Origination TV equipment consisting of two Panasonic Mini-Studios. Quick-Set Camera Trip Assemblies, Panasonic 3130 and 3120 Video Tape Recorders and 3110 Video Tape Player, Panasonic Cameras Model WV-360P, Sony Porta-Pak Video Tape Recorder, Microphones, Cables and Much more. Call Bob Ingstad at WFX Radio, (605) 224-8686 or write KGFX Radio, Box 17, Pierre, South Dakota. 57501

CRTRIDGE TAPE EQUIPMENT—Rebuilt. New paint, lids, flywheel, pressure roller, belts etc. Spotlessly clean and thoroughly tested. 30 day money-back guarantee, 90 day warranty. Also contact us for discounts on new equipment and accessories.

AUTODYNE, Box 1004,  
Rockville, Maryland 20850  
(301) 762-7626.

BROADCAST AND RECORDING EQUIPMENT: Sull V.I.F. International, Metrotech, Langevin, Electronic, Q.R.K., Micro-Trak, MRL, Nortronics, McMartin, R.E.T., E.V., A.K.G., Stevenson, Gately, D.B.X., Adnt, Altec, Fairchild, Audio Designs, 3M, Magnecord, Tel, Inovonics, Nagra, Uher, Tape-Athon, Package Deals, installations, Service, Request Flyer. Weigand Audio, Middleburg, PA. 17842. (717) 837-1444.

COMBINING AMP CARDS from \$40.00. Fully tested and guaranteed for 10 years. Distribution amps, line amps, c preamps, transformer cards, card files and power supplies. Electronic crossovers and equalizers. Direct from manufacturer. NO DISTRIBUTOR MARKUP! IXTLAN ENGINEERING, Box 323, Lombard, Ill. 60148. (312) 3-6362.

FIELD STRENGTH METER. 540 KHz to 5MHz, Ten microvolts to 10 volts per meter. New solid state design, long battery life. Stable accurate calibration. Free literature. Solar Electronics, 901 No. Highland Ave., Hollywood, pl. 90038.

#### MOTORS FOR SPOTMASTERS

EW Papst hysteresis synchronous motor HSZ 50-4-470D as used in series 400 and 500 machines. Price \$9.00 each prepaid while they last. 90 day warranty. Terms check with order only, no COD's. Not recommended for recaster series 600 or 700.

TAPECASTER TCM, INC., Box 662  
Rockville, Maryland 20851

### EQUIPMENT FOR SALE (Cont'd)

Two 3M professional audio record/playback tape recorders, series 410, complete within console cabinets. Purchased new February 1973. Record heads like new. \$2,900 each FOB Fresno, CAL. Phone KKNU (209) 485-7272.

Moseley 450Mc remote pickup link, RCVR and Xmitter. Excellent condition. Scala PR-150 antenna, still in original crate. McMartin TBM3000, McMartin TBM3500, McMartin 2500. Contact Bob Ripley, Chief Engineer, KYDAM-FM, 1216 State Street, Santa Barbara, CAL. 93101

Solid-state audio modules-console kits, power amplifier kits, power supplies. Octal plug-ins—mic, eq. line, disc, tape play, tape record, amplifiers. Audio & tape bias oscillators. Over 50 audio products. Send for free catalog and applications. Opamp Labs, Inc., 172 So. Alta Vista Blvd., Los Angeles, Calif. 90036. (213) 934-3566.

Surplus Audio Patch Panels All Standard Configurations. Gulf Telephone & Electronics, Inc. 6235 Beverly Hill, Houston, Texas 77027.

The complete and reliable source for new and used broadcast equipment. Request our free listings. Broadcast Equipment and Supply Co., Box 3141, Bristol, Tennessee 37620.

MICA AND VACUUM transmitting capacitors. Large stock; immediate delivery. Price lists on request. SURCOM ASSOCIATES, 1147 Venice Blvd., Los Angeles, Cal. 90015 (213) 382-6985.

1—650 ft. towers \$6500.00 each. Many more. Ground wire 85c per xx. lb. Bill Angle, Box 55, Greenville, N.C. 27834. Tel. 919-752-3040.

ONE STOP for all your professional audio requirements. Bottom line oriented F.T.C. Brewer Co. P.O. Box 8057, Pensacola, FL. 32505.

CAPSTAN IDLERS for AMPEN 300, 350, 440. Series, self aligning with replaceable ball bearings. \$22.50 net. VIF INTERNATIONAL, Box 1555, Mtn. View, Ca. 94040.

### PROFESSIONAL CARDS

COHEN & DIPPELL  
CONSULTING ENGINEERS  
Formerly GEO. C. DAVIS  
527 Munsey Bldg.  
(202) 783-0111  
Washington, D. C. 20004  
Member AFCEE

JANSKY & BAILEY  
TeleCommunications Consulting  
Department  
CATV & CCTV  
Phone 703/354-3400-ext. 722 or 2400  
Shirley Hiway at Edsall Road  
Alexandria, Virginia 22314  
Atlantic Research Corporation

CHU ASSOCIATES, INC.  
Telecommunications Division  
AM—FM—TV—CATV  
Applications—Facilities Planning  
Field Surveys and Proofs  
Appraisals  
800 Fesler St., El Cajon, Ca. 92020  
(714) 442-9459  
TWX 910 331 1178

### PROFESSIONAL CARDS (Cont'd)

#### BROADCAST STUDIO DESIGN

Control Systems, Facilities Planning,  
Plant Layout & Manufacturing

#### DYMA ENGINEERING, INC.

Route 1, Box 51, Taos, New Mexico 87571  
Phone: 505/758-2686

### RALPH E. EVANS ASSOCIATES

Consulting Radio Engineers  
AM - FM - TV - CATV - ITFS

3500 North Sherman Blvd.

MILWAUKEE, WISCONSIN 53216

Phone: 414-442-4210

### McCLANATHAN & ASSOCIATES

Consulting Engineers

APPLICATIONS & FIELD ENGINEERING  
TURNKEY INSTALLATIONS—RADIO & TV  
Domestic and Foreign

P. O. Box 750  
PORTLAND, OREGON 97207

Phone: 503/246-8080

VIR JAMES  
CONSULTING RADIO ENGINEERS  
Applications and Field Engineering  
Computerized Frequency Surveys  
345 Colorado Blvd.—80206  
(303) 333-5562  
DENVER, COLORADO  
Member AFCEE

### PROGRAM SERVICES

"Free" Catalog . . . Everything for the deejay! Comedy, books, airchecks, wild tracks, old radio shows, and more! Write: Command, Box 26348-A, San Francisco 94126.

Deejays! New Comedy! 11,000 classified one-line gags, \$10. Catalog FREE! Edmund Orrin, 2786-M West Roberts, Fresno, CA. 93705.

TAPES FOR AUTOMATION



**THE GNB STUDIOS**  
Specializing in Custom Services

3415 BERESFORD AVENUE  
BELMONT, CALIFORNIA 94002  
415 / 592-6149

### INSTRUCTIONS

FCC FIRST CLASS RADIOTELEPHONE LICENSE IN SIX WEEKS. Classes in Dallas, Atlanta, Denver, Ft. Worth, Hartford, Houston, Memphis, Nashville, New Orleans, Oklahoma City, and San Antonio. For information contact Elkins Institute, 2727 Inwood Rd., Dallas, Tex. 75235 214/357-4001.

ATTENTION VETERANS! First class license in five weeks with complete theory and R.C.A. equipped laboratory training. Approved for veterans Tuition \$333.00. Housing cost \$16.00 per week. American Institute of Radio, 2622 Old Lebanon Road, Nashville, Tenn. 37214. 615-889-0469.

First phone through tape recorded lessons at home plus one week personal instruction in Washington, D.C., Atlanta, Boston, Detroit, New Orleans, Minneapolis, Seattle, Denver, Portland, Los Angeles. Proven results. Our 17th year teaching FCC license courses. Bob Johnson Broadcast License Training, 1060D Duncan, Manhattan Beach, Calif. 90266. 213-379-4461.



## The simple, solid cart machines.

Now, your cart tapes can sound the way you want them to sound; clear, clean and flat with QRK cartridge equipment.

- 150 cycle tone as standard feature.
- Direct drive.
- Solid state electronics.
- Compact. (Playback machine only 5-3/4" wide).

Contact your local QRK dealer or inquire direct.



**ELECTRONIC PRODUCTS, INC.**

1568 North Sierra Vista, Fresno, California 93707  
Phone (209) 251-4213

A subsidiary of CCA Electronics Corp.

Circle 175 on Reader Service Card

## SALES OFFICES

**Broadband Information Services, Inc.**  
274 Madison Avenue  
New York, New York 10016

### EASTERN & MIDWESTERN STATES

274 Madison Avenue  
New York, New York 10016  
212-685-5320  
Charles C. Horner

### WESTERN STATES

1111 Hearst Building  
San Francisco, California 94130  
415-362-8547  
William J. Healey

16400 Ventura Blvd.  
Encino, California 91316  
213-981-0611  
Art Mandell

### JAPAN

Nippon Keisoku Inc.  
P.O. Box 410  
Central Tokyo, Japan  
Tokyo (03) 667-7681  
Yoshi Yamamoto

**USE BM/E'S CLASSIFIED  
MARKETPLACE TO  
REACH OVER 28,000  
BROADCASTERS!**

## ADVERTISERS' INDEX

AKAI America, Ltd.	13
AKG-Philips	59
American Data Corp.	9
Ampex Corp.	CM/E-5
Anaconda Electronics	CM/E-2
Audio Devices, Inc.	39
Audio Services, Inc.	83
Audltronics, Inc.	79
Avantek, Inc.	CM/E-4
Belar Electronics Laboratory, Inc.	43
Boston Insulated Wire & Cable Co.	60
Broadcast Electronics, Inc.	25
CBS Laboratories, A Div. of CBS Broadcast Systems, Inc.	70
Canon, U.S.A. Inc.	73
Canon Scoopic Div.	27
Central Dynamics, Ltd.	51
Cetec, Inc.	78, 84, 89
Cinema Products Corp.	32, 49
Cohu Electronics, Inc.	41
Collins Radio Co.	45
Commercial Electronics, Inc.	Cover 2
Cosmicar Optical Co., Ltd.	52
Dynair Electronics, Inc.	1
Dynasciences Corp.	23, 8
Eastman Kodak Co.	35
Eimac, Div. of Varian	17
Electrohome, Ltd.	11
Fidelpac Div. of Telepro Industries, Inc.	71
Fort Worth Tower Co.	93
GTE Sylvania—Electronic Components	CM/E-6
Garner Electronics	7
Grass Valley Group, Inc., The	1
Hitachi Shibaden Corp. of America	7
International Tapetronics Corp.	72, 76, 84
Listek Television Equipment Corp.	81
McMartin Industries, Inc.	74, 81
Magnasync/Moviola Corp.	11
Marco Video Systems, Inc.	8
Memorex Corp.	Cover
Micro-Trak Corp.	8
Miratel Div. Ball Bros. Research Corp.	1
Moseley Associates, Inc.	6
Myers-Oak Communications Construction Group	CM/E-1
Neve, Inc., Rupert	1
Oak Industries, Inc. Communications Group	CM/E-9, 11
Pacific Recorders & Engrg. Corp.	73, 8
Potomac Instruments, Inc.	7
QRK	9
RCA Broadcast Systems	19, 20, 21, 2
Rapid Q	8
Recortec, Inc.	44, 4
Robins-Fairchild	8
Sansui Electric Co., Ltd.	51
Schafer Electronics Corp.	8
Scientific Atlanta/Optima Div.	5
Scully/Metrotech Div. of Dictaphone	8
Shure Bros. Inc.	4
Soladyne International, Inc.	5
Sony Corp. of America	CM/E-1
Spindler & Säupe	1
Stanton Magnetics, Inc.	7
Tascam Corp.	1
Tech Labs., Inc.	7
Telecommunications Industries, Ltd.	1
Telemet/A Goetel Co.	Cover
Telemation, Inc.	1
Television Equipment Associates	1
Television Microtime, Inc.	1
Television Products Co., Inc.	1
Telex Communications, Inc.	1
Timekeeper	1
Time & Frequency Technology, Inc.	1
Val-Tronics, Inc.	1
Videomax Corp.	1
Viscount Industries, Ltd.	1
Wilkinson Electronics Inc.	74, 87, 1
World Video, Inc.	1



## Small Tower Site? Install an S3T Self-Supporting Tower

- ▶ Basic design for a 40PSF wind-load and for support of two 10 ft. diameter high-performance antennas or two 10x15 reflectors with rigidity required for 12 GHz systems.
- ▶ Designs for heavier wind or antenna loadings available to meet your system specifications.
- ▶ Available in heights to 300 feet with construction in increments of 25 feet. Varying heights available to your specifications.
- ▶ Triangular Cross Section design—tubular construction with inside climbing ladder. All materials hot-dipped galvanized after fabrication.
- ▶ Design criteria in accordance with EIA Standard RS-222-A. All steel used in fabrication conforms to ASTM designation A-36.



**Fort Worth Tower Co., Inc.**

P.O. BOX 8597 / 6201 BRIDGE STREET / FORT WORTH, TEXAS 76112  
FORT WORTH PH. (817) JE 6-5676 • DALLAS PH. (214) AN 4-2822

Circle 176 on Reader Service Card

FOR MORE INFORMATION ON CCA'S  
Studio consoles, write to:  
CCA ELECTRONICS CORP.  
716 Jersey Avenue  
Gloucester City, N. J. 08030

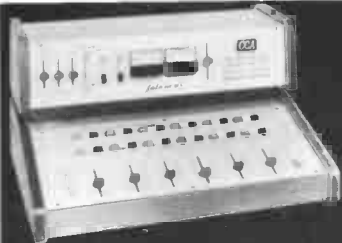

The **CCA Futura 6 & 10 Audio Consoles** are available in both mono and stereo versions. Incorporates modern slide faders, optimum capacity and performance specs.

## YOUR BEST BUY FOR STUDIO CONSOLES

Send this advertisement  
for more information

**CCA ELECTRONICS CORPORATION**  
716 Jersey Avenue  
Gloucester City, N. J. 08030  
(609) 456-1716

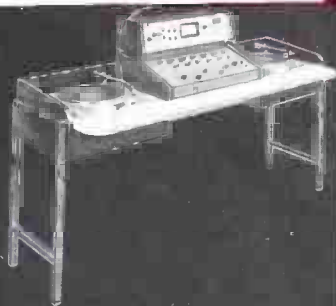

**CCA Futura** prewired systems permit broadcasters to install complete system in a matter of minutes. Contains receptacles for all normal studio functions. Available in mono and stereo.



**CCA SOLID STATE 40 WATT-HI FIDELITY TRANSMITTERS AND RECEIVERS** permit you to originate programs from remote locations — designed for 115VAC or mobile use. Three inputs with mixing — 15 Kc response.

## SAVE ON TELEPHONE EXPENSE with CCA REMOTE PICK UP and STUDIO TRANSMITTER LINKS

Send this advertisement  
for more information

**CCA ELECTRONICS CORPORATION**  
716 Jersey Avenue  
Gloucester City, N. J. 08030  
(609) 456-1716



**CCA SOLID STATE STUDIO-TRANSMITTER LINKS** available for 200 Mc, 300 Mc, 450 Mc and 900 Mc. 10 Watts output High Fidelity good for Mono or composite input. Plug-in modular construction.

FOR MORE INFORMATION ON CCA'S  
AM/FM Transmitters, write to:  
CCA ELECTRONICS CORP.  
716 Jersey Avenue  
Gloucester City, N. J. 08030

**50 KW AM**  
with conventional high level  
modulation and air cooling.



You are cordially invited to visit  
our plant and watch the AM  
50,000 go through its paces!

## CCA AM/FM TRANSMITTERS ARE WITHOUT COMPARISON

Send this advertisement  
for more information

**CCA ELECTRONICS CORPORATION**  
716 Jersey Avenue  
Gloucester City, N. J. 08030  
(609) 456-1716

**25 KW AM**  
air cooled transmitter with in-  
dependent 3 KW driver and one  
power amplifier tube.

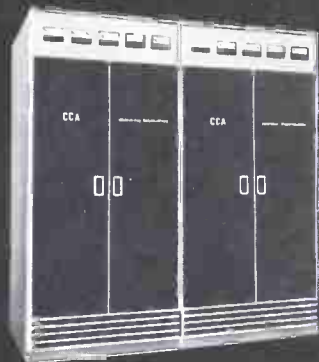

FOR MORE INFORMATION ON CCA RF  
Industries' UHF TV transmitters, write to:  
CCA ELECTRONICS CORP.  
716 Jersey Avenue  
Gloucester City, N. J. 08030

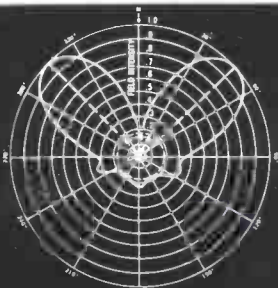

Typical measured Pattern #21  
Peak hor. power gain 3.38

CCA patented TV antennas  
can provide you with the  
exact pattern you require —  
normally at no extra cost and  
at a minimum of tower load-  
ing! We can prove its pattern

## YOUR BEST COMBINATION FOR UHF-TV COVERAGE

Send this postcard for more  
information

**CCA RF INDUSTRIES INC.**  
P. O. Box 315  
Westfield, Mass. 01085

A Subsidiary of CCA Industries



CCA UHF-TV transmitters have  
been in service for over 10  
years in more than 40 loca-  
tions. From 15 kw to 110 kw.  
No other company can match  
our reliability.

Name \_\_\_\_\_  
Station or Firm \_\_\_\_\_  
Address \_\_\_\_\_  
City \_\_\_\_\_

FIRST CLASS  
PERMIT NO. 128  
GLOUCESTER CITY,  
NEW JERSEY

**BUSINESS REPLY CARD**  
NO POSTAGE NECESSARY IF MAILED IN THE U. S.

Postage will be paid by:

**CCA ELECTRONICS CORP.**  
716 Jersey Avenue  
Gloucester City, New Jersey 08030

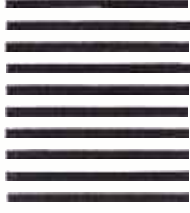

Name \_\_\_\_\_  
Station or Firm \_\_\_\_\_  
Address \_\_\_\_\_  
City \_\_\_\_\_

FIRST CLASS  
PERMIT NO. 128  
GLOUCESTER CITY,  
NEW JERSEY

**BUSINESS REPLY CARD**  
NO POSTAGE NECESSARY IF MAILED IN THE U. S.

Postage will be paid by:

**CCA ELECTRONICS CORP.**  
716 Jersey Avenue  
Gloucester City, New Jersey 08030



Name \_\_\_\_\_  
Station or Firm \_\_\_\_\_  
Address \_\_\_\_\_  
City \_\_\_\_\_

FIRST CLASS  
PERMIT NO. 128  
GLOUCESTER CITY,  
NEW JERSEY

**BUSINESS REPLY CARD**  
NO POSTAGE NECESSARY IF MAILED IN THE U. S.

Postage will be paid by:

**CCA ELECTRONICS CORP.**  
716 Jersey Avenue  
Gloucester City, New Jersey 08030

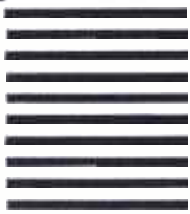

Name \_\_\_\_\_  
Station or Firm \_\_\_\_\_  
Address \_\_\_\_\_  
City \_\_\_\_\_

FIRST CLASS  
PERMIT NO. 128  
GLOUCESTER CITY,  
NEW JERSEY

**BUSINESS REPLY CARD**  
NO POSTAGE NECESSARY IF MAILED IN THE U. S.

Postage will be paid by:

**CCA ELECTRONICS CORP.**  
716 Jersey Avenue  
Gloucester City, New Jersey 08030

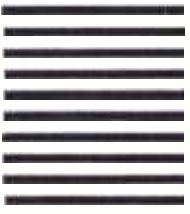

More TV Chief Engineers own RCA color TV than any other set.

Now you can get the same solid state color fidelity and reliability in a low cost studio viewing monitor.

The new RCA color receiver/monitor has a 100% solid state chassis. And this big 25-inch color commercial receiver handles RF or bridged direct video and audio feed lines. Live or taped programs. Color or black-and-white.

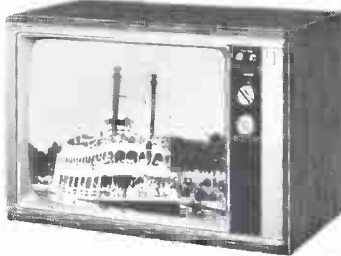

With Super AccuColor black-matrix picture tube quality, and all the right connections — from a rear control panel that offers versatile audio-visual applications. More of what you're looking for — for less.

**RCA**

SEND THIS POSTCARD FOR MORE INFORMATION OR CALL

RCA Service Company  
Commercial Products Sales  
(609) 779-5892

You already own half of a variable speed turntable.

Here's the other half.

Just plug your present turntable into the QRK Electronic Speed Control and you have variable speed instantly.

- Dual purpose switch for normal or variable speed operation
- Solid state throughout.



**ELECTRONIC PRODUCTS, INC.**  
1568 North Sierra Vista, Fresno, California 93707  
Phone (209) 251-4213

A subsidiary of CCA Electronics Corp.

Contact your local QRK dealer or inquire direct.



Because this broadcast turntable is the first of its kind...

we've called it the **Alpha**

Nothing really new has happened to professional turntables in 30 years; since 1944, when QRK introduced the world's first **instant start**, fast cue turntable. Now, it's the electronic speed controlled ALPHA. The rugged, quiet, **instant** starting ALPHA from QRK. The first really new turntable in a generation.

- Electronic speed control
- Exclusive cue control for instant cue
- New thump resistant idler
- Hysteresis synchronous motor.

Contact your local QRK dealer or inquire direct.

**QRK ELECTRONIC PRODUCTS, INC.** A subsidiary of CCA Electronics Corp.  
1568 No. Sierra Vista, Fresno, Ca. 93707 • Phone (209) 251-4213

Find Cartridge  
Tape Splices  
Automatically



This unique new Senstrol splice finder and bulk eraser can be a major labor saver for AM and FM radio stations in the processing of tape cartridges. The splice finder, operating at 15 IPS, will automatically locate a tape splice within 1 inch beyond the capstan and eject the cartridge. Station personnel are free to perform other functions rather than visually inspecting each tape to find the splice. An optional built-in bulk eraser is included to save additional studio manhours for cartridge handling.

The splice finder will pay for itself by reducing operating expenses. Our catalog sheet gives complete specifications and ordering information. Ask for it.

Name \_\_\_\_\_  
Company \_\_\_\_\_  
Title \_\_\_\_\_  
Address \_\_\_\_\_ City \_\_\_\_\_  
State \_\_\_\_\_ Zip \_\_\_\_\_

RCA SERVICE CO. DEPT E-143X BLDG. 203-3  
Camden, N.J. 08101

QRK ELECTRONIC PRODUCTS, INC.  
1568 North Sierra Vista  
Fresno, California 93707

QRK ELECTRONIC PRODUCTS, INC.  
1568 North Sierra Vista  
Fresno, California 93707

FOR MORE INFORMATION ON  
Sensrol Div. UMC Electronics Co.  
460 Sackett Point Road  
North Haven, Conn. 06473

First Class  
Permit No. 16  
Camden, N.J.

**BUSINESS REPLY MAIL**

No postage stamp necessary if mailed in the United States

Postage will be paid by:

RCA Service Company  
A Division of RCA  
Commercial Products Sales,  
Dept. E-143X, Building 203-3  
Camden, N.J. 08101

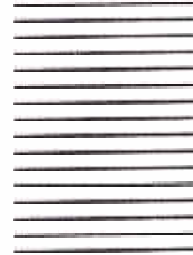

Name \_\_\_\_\_  
Title \_\_\_\_\_  
Station \_\_\_\_\_  
Address \_\_\_\_\_  
City \_\_\_\_\_ State \_\_\_\_\_ Zip \_\_\_\_\_

FIRST CLASS  
PERMIT  
NO. 2316  
FRESNO  
CALIFORNIA

**BUSINESS REPLY CARD**

NO POSTAGE NECESSARY IF MAILED IN THE U.S

Postage will be paid by:

**QRK ELECTRONIC PRODUCTS, INC.**  
1568 North Sierra Vista  
Fresno, California 93707



Name \_\_\_\_\_  
Station or Firm \_\_\_\_\_  
Address \_\_\_\_\_  
City \_\_\_\_\_ State \_\_\_\_\_ Zip \_\_\_\_\_

FIRST CLASS  
PERMIT  
NO. 2316  
FRESNO  
CALIFORNIA

**BUSINESS REPLY CARD**

NO POSTAGE NECESSARY IF MAILED IN THE U.S

Postage will be paid by:

**QRK ELECTRONIC PRODUCTS, INC.**  
1568 North Sierra Vista  
Fresno, California 93707



Name \_\_\_\_\_  
Station or Firm \_\_\_\_\_  
Address \_\_\_\_\_  
City \_\_\_\_\_ State \_\_\_\_\_ Zip \_\_\_\_\_

FIRST CLASS  
PERMIT NO. 138  
NORTH HAVEN,  
CONN.

**BUSINESS REPLY MAIL**

NO POSTAGE STAMP NECESSARY IF MAILED IN THE UNITED STATES

POSTAGE WILL BE PAID BY:

Charles Collett, Sales Manager  
Sensinol Division  
UMC Electronics Co  
460 Sackett Point Road  
North Haven, Connecticut 06473





# BM/E READER SERVICE CARD / May 1974 Issue

Use this FREE postpaid card for more information on the products described.

TELL US WHAT YOU LIKE OR DISLIKE ABOUT THIS ISSUE:

NAME ..... TITLE .....

STATION OR COMPANY .....

WHAT ARTICLES WOULD YOU LIKE TO SEE?

ADDRESS .....

CITY ..... STATE ..... ZIP .....

100-249: ADS / 250-299: LIT / 300-450: EDITORIAL

USE UNTIL AUGUST 31, 1974

101	102	103	104	105	106	107	108	109	110	111	112	113	114	115	116	117	118	119	120	121	122	123	124	125	126	127	128	129	130	131	132	133	134	135																				
137	138	139	140	141	142	143	144	145	146	147	148	149	150	151	152	153	154	155	156	157	158	159	160	161	162	163	164	165	166	167	168	169	170	171																				
173	174	175	176	177	178	179	180	181	182	183	184	185	186	187	188	189	190	191	192	193	194	195	196	197	198	199	200	201	202	203	204	205	206	207																				
209	210	211	212	213	214	215	216	217	218	219	220	221	222	223	224	225	226	227	228	229	230	231	232	233	234	235	236	237	238	239	240	241	242	243																				
245	246	247	248	249																																																		
																									250	251	252	253	254	255	256	257	258	259	260	261	262	263	264	265	266	267	268	269	270	271	272	273	274	275	276	277	278	279
281	282	283	284	285	286	287	288	289	290	291	292	293	294	295	296	297	298	299												300	301	302	303	304	305	306	307	308	309	310	311	312	313	314	315									
317	318	319	320	321	322	323	324	325	326	327	328	329	330	331	332	333	334	335	336	337	338	339	340	341	342	343	344	345	346	347	348	349	350	351																				
353	354	355	356	357	358	359	360	361	362	363	364	365	366	367	368	369	370	371	372	373	374	375	376	377	378	379	380	381	382	383	384	385	386	387																				
389	390	391	392	393	394	395	396	397	398	399	400	401	402	403	404	405	406	407	408	409	410	411	412	413	414	415	416	417	418	419	420	421	422	423																				
425	426	427	428	429	430	431	432	433	434	435	436	437	438	439	440	441	442	443	444	445	446	447	448	449	450																													

# BM/E READER SERVICE CARD / May 1974 Issue

Use this FREE postpaid card for more information on the products described.

TELL US WHAT YOU LIKE OR DISLIKE ABOUT THIS ISSUE:

NAME ..... TITLE .....

STATION OR COMPANY .....

WHAT ARTICLES WOULD YOU LIKE TO SEE?

ADDRESS .....

CITY ..... STATE ..... ZIP .....

100-249: ADS / 250-299: LIT / 300-450: EDITORIAL

USE UNTIL AUGUST 31, 1974

101	102	103	104	105	106	107	108	109	110	111	112	113	114	115	116	117	118	119	120	121	122	123	124	125	126	127	128	129	130	131	132	133	134	135																				
137	138	139	140	141	142	143	144	145	146	147	148	149	150	151	152	153	154	155	156	157	158	159	160	161	162	163	164	165	166	167	168	169	170	171																				
173	174	175	176	177	178	179	180	181	182	183	184	185	186	187	188	189	190	191	192	193	194	195	196	197	198	199	200	201	202	203	204	205	206	207																				
209	210	211	212	213	214	215	216	217	218	219	220	221	222	223	224	225	226	227	228	229	230	231	232	233	234	235	236	237	238	239	240	241	242	243																				
245	246	247	248	249																																																		
																									250	251	252	253	254	255	256	257	258	259	260	261	262	263	264	265	266	267	268	269	270	271	272	273	274	275	276	277	278	279
281	282	283	284	285	286	287	288	289	290	291	292	293	294	295	296	297	298	299												300	301	302	303	304	305	306	307	308	309	310	311	312	313	314	315									
317	318	319	320	321	322	323	324	325	326	327	328	329	330	331	332	333	334	335	336	337	338	339	340	341	342	343	344	345	346	347	348	349	350	351																				
353	354	355	356	357	358	359	360	361	362	363	364	365	366	367	368	369	370	371	372	373	374	375	376	377	378	379	380	381	382	383	384	385	386	387																				
389	390	391	392	393	394	395	396	397	398	399	400	401	402	403	404	405	406	407	408	409	410	411	412	413	414	415	416	417	418	419	420	421	422	423																				
425	426	427	428	429	430	431	432	433	434	435	436	437	438	439	440	441	442	443	444	445	446	447	448	449	450																													

# COMPLIMENTARY SUBSCRIPTION QUALIFICATION CARD

I would like to receive BM/E  Yes  No

I would like my copies to include CM/E  Yes  No

Name ..... Title .....

Station or Co. ....

Street .....

City ..... State ..... Zip .....

If this is an address change, affix label

My company is: (Please check ALL items which pertain to your firm.)

- AM Station(s)
- FM Station(s)
- TV Station(s)
- Instructional TV or CCTV
- Campus Limited Radio
- CATV Facilities
- Telephone Company
- Program Sources
- Recording Studios
- Government
- Consultant
- Lawyer
- Distributor/Manufacturer dealer
- Other (please specify) .....

Are you responsible for more than one station or facility?

Yes  No

Is this your business address?  Yes  No

My primary area of responsibility is: (Please check one)

- Corporate Management
- Engineering & Engineering Management
- Operations Management
- Station, Production or Program Management
- Other (please describe) .....

If not, please give us your business address below so that we can avoid sending duplicate copies.

Name .....

Station or Co. ....

Street .....

Your signature .....

Title ..... Date .....

City ..... State ..... Zip .....

# BUSINESS REPLY MAIL

NO POSTAGE STAMP NECESSARY IF MAILED IN THE UNITED STATES

POSTAGE WILL BE PAID BY



Broadband Information Services, Inc.

P.O. BOX 6058

Duluth, Minnesota 55806

FIRST CLASS

Permit No. 665  
Duluth, Minnesota

# BUSINESS REPLY MAIL

NO POSTAGE STAMP NECESSARY IF MAILED IN THE UNITED STATES

POSTAGE WILL BE PAID BY



Broadband Information Services, Inc.

P.O. BOX 6058

Duluth, Minnesota 55806

FIRST CLASS

Permit No. 665  
Duluth, Minnesota

# BUSINESS REPLY MAIL

NO POSTAGE STAMP NECESSARY IF MAILED IN THE UNITED STATES

POSTAGE WILL BE PAID BY



Broadband Information Services, Inc.

P.O. BOX 6056

Duluth, Minnesota 55806

FIRST CLASS

Permit No. 665  
Duluth, Minnesota

# Our Solid-State Sideband Analyzer has all the features you want under the sun.

## At a down-to-earth price.

Designed and built with the same care and quality as our solid-state Precision Demodulator and Group (Envelope) Delay units, the Model 3706 Sideband Analyzer has a lot to offer.

- Like 50dB dynamic display. Single channel, crystal controlled, plug-in tuner.
- 7 individual crystal controlled frequency markers.
- 1 MHz comb frequency markers. Variable pedestal control (10 to 90 IRE units). I.F. bandwidth  $\pm 5$ Kc.
- Sync and blanking internally added to test signal.



MODEL 4501 BROADCAST DEMODULATOR VHF: \$3450 UHF: \$3600

What's more, it requires no external black boxes. And the price is only \$4450. So, you pay a lot less than those imported units, without sacrificing quality or efficiency.

Learn how our low cost trio can help you set-up, test and monitor your transmitter quickly and efficiently. Write or call us today.

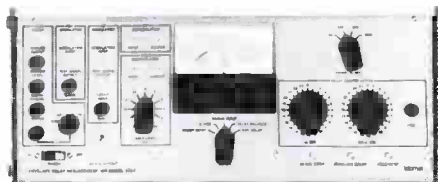

MODEL 3705 GROUP DELAY TEST SET \$4100

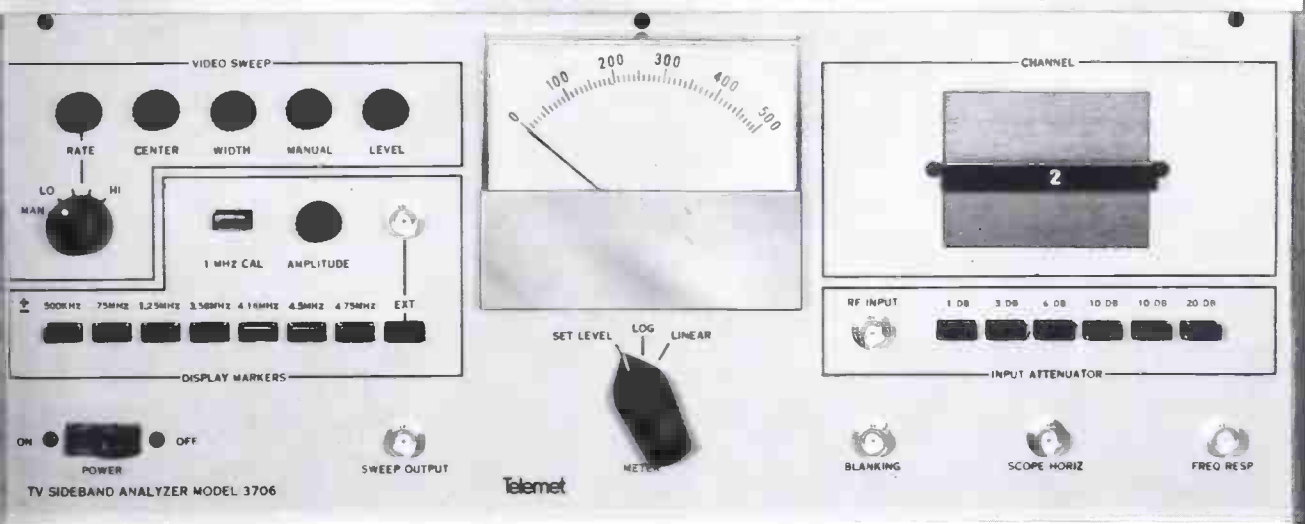

MODEL 3706 SIDEBAND ANALYZER \$4450



Amityville, New York 11701, (516) 541-3600 TWX #5102279850

### REGIONAL OFFICES

Chicago, Ill. (312) 627-6026 Atlanta, Ga. (404) 294-5809 Riverside, Calif. (714) 683-0641  
Toronto Canada. MSC Electronics (416) 661-4180.

Circle 177 on Reader Service Card

# Memorex Video Cassette quality lasts



100 passes.

## and lasts



200 passes.

## and lasts



300 passes.

## and lasts



400 passes.

## and lasts.



500 passes.

As you can see, the Memorex Chromium Dioxide Cassette picture is still sharp after 500 passes. And we're confident you'll discover the same high quality throughout our entire video tape line, which includes all popular configurations for both helical scan and broadcast applications.

(All unretouched photos.)



## MEMOREX VIDEO TAPE.

©1974, Memorex Corporation, Santa Clara, California 95052

Circle 178 on Reader Service Card